

MAGIC CYLINDER LIGHT

Monopoint Pendant / Surface / Spotlight / Track Light



PRODUCT DESCRIPTION

This architectural Magic Cylinder Light is designed for accent lighting and features a state-of-the-art design. Thanks to the detachable tool-less modular design, the luminaire can be used as commercial pendant light, surface mounted light, monopoint spotlight, and track light. The anti-glare design allows for ideal control of visual comfort. It is widely used in shops and other commercial applications.

FEATURE

- Tool-less modular design
- Monopoint pendant, surface and track mounted
- Interchangeable Beam Spread: 15°/24°/38°/60°
- Anti-glare design to reduce glare light
- Triac dimmable, compatible with both by MLV or ELV dimmer
- Integral driver, isolated circuit
- Cree LED chips, CRI90

ELECTRICAL SYSTEM

- Input Voltage: 120V, 50/60Hz
- Minimum Ambient -20°C, Maximum Ambient is 40°C
- Power Factor: > 0.9 at full load
- Total Harmonic Distortion: < 20% at full load

SPECIFICATION

10W/15W Pendant

Net. Weight: 1.5lbs

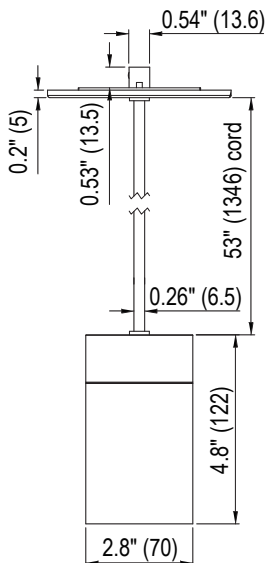

22W Pendant

Net. Weight: 2.1lbs

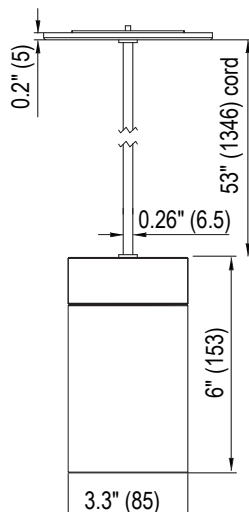

Mount Canopy
for 10W/15W/22W

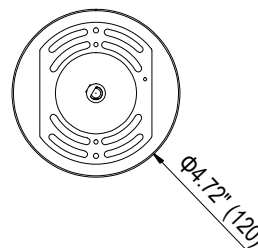

PERFORMANCE

CRI

90Ra

CCT

2700K, 3000K, 3500K, 4000K, 5000K

Dimming

Triac Dimming

Projected Lifetime

L70 - 100,000 Hours

Working Temperature

-4-104°F (-20-40°C)

Certifications

- cETLus conforms to UL Std. 1598
Cert. to CSA Std. C22.2 No.250.0
- Suitable for dry locations
- RoHs compliant

10W/15W Surface

Net. Weight: 1.3lbs

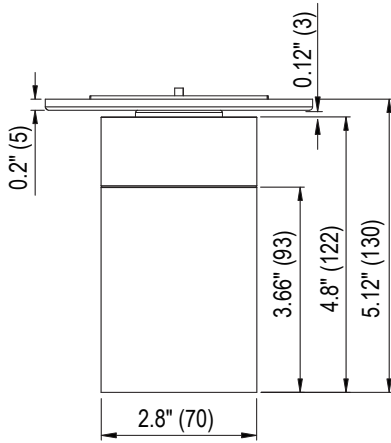

22W Surface

Net. Weight: 1.9lbs

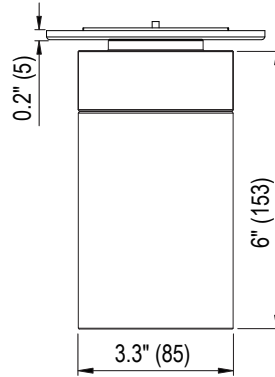

10W/15W Spotlight

Net. Weight: 1.3lbs

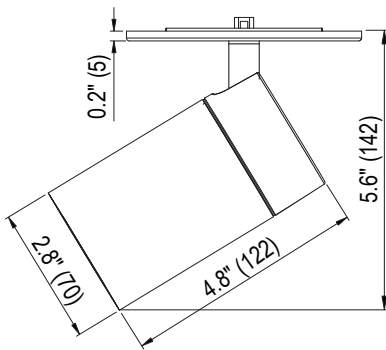

22W Spotlight

Net. Weight: 1.9lbs

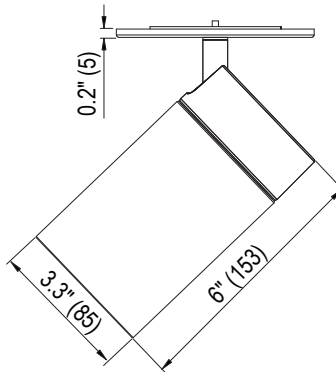

10W/15W Track Light

Net. Weight: 1.1lbs

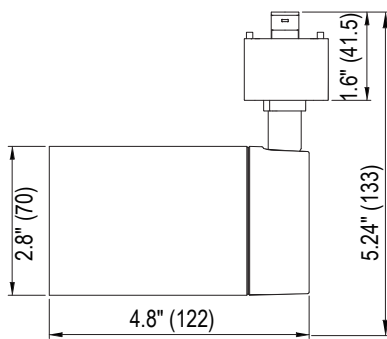

22W Track Light

Net. Weight: 1.7lbs

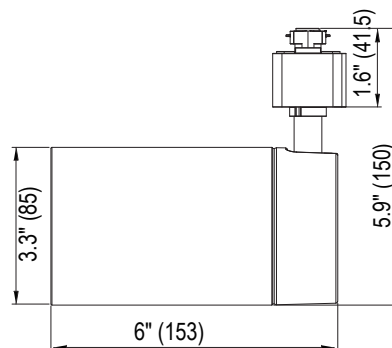

Ordering Information

Example: MCL22-30904-38-MBK

Strip	Watts	- CCT&CRI ¹	Voltage	- Beaming Angle ²	Installation ³	- Controls	- Finish
MCL	10 - 10 Watts	- 2790 - 2700K 90Ra	4 - 120V	- 15 -15 degree	Ordered and shipped separately³ MCL-PMK MCL-SMK MCL-STMK MCL-HTMK ⁴ MCL-JTMK ⁵ MCL-LTMK ⁶	- Blank - None	- MBK - Matt Black MWH - Matt White
	15 - 15 Watts	3090 - 3000K 90Ra		- 24 -24 degree			
	22 - 22 Watts	3590 - 3500K 90Ra		- 38 -38 degree			
		4090 - 4000K 90Ra		- 60 -60 degree			
		5090 - 5000K 90Ra					

- 3000K is standard. All the other CCT has MOQ requirement. Please contact Customer Service for details.
- 38° and 60° are standard. 15° and 24° has MOQ requirement. Please contact Customer Service for details.
- Mount kits need to be bought and shipped separately. Please check the accessory table for details. If these mount kits need to be installed on fixture before shipping please contact Customer Service in advance.
- H type - operates on Halo Cooper Single Circuit track or Powergear track.
- J type - operates on Juno Single or Dual Circuit Track System but works as single circuit track.
- L type - operates on Lightolier Signify Single Circuit Track.

* White and black finish are standard. Additional charge will apply for other customized finish colors and longer lead time.

Accessories (Ordered and shipped separately)



MCL-PMK-10/15
MCL-PMK-22
Pendant Mount Kits for Magic Cylinder Light



MCL-SMK-10/15
MCL-SMK-22
Surface Mount Kits for Magic Cylinder Light



MCL-STMK-10/15
MCL-STMK-22
Spotlight Mounted Kits for Magic Cylinder Light



MCL-HTMK-10/15
MCL-HTMK-22
H-type Single Circuit Track Mount Kits for Magic Cylinder Light



MCL-JTMK-10/15
MCL-JTMK-22
J-type Single Circuit Track Mount Kits for Magic Cylinder Light



MCL-LTMK-10/15
MCL-LTMK-22
L-type Single Circuit Track Mount Kits for Magic Cylinder Light

Accessories (Ordered and shipped separately)

* All these following accessories have MOQ requirement. Please contact Customer Service for details.



MCL-ST-10/15
Snoot for 10W/15W
Magic Cylinder Light

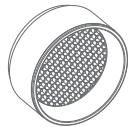

MCL-HCL-10/15
Honey Comb Louver for
10W/15W Magic Cylinder Light



MCL-WW-10/15
Wall Washer for 10W/15W
Magic Cylinder Light

MCL-ST-22
Snoot for 22W
Magic Cylinder Light

MCL-HCL-22
Honey Comb Louver for
22W Magic Cylinder Light

PHOTOMETRY

All published luminaire photometric testing performed to IESNA LM-79-08 standards by a NVLAP certified laboratory.

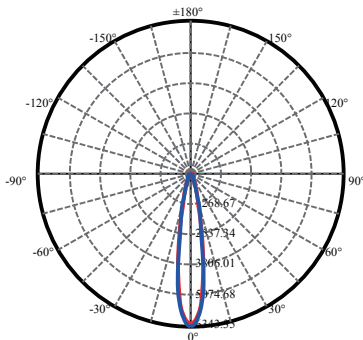

15 degree

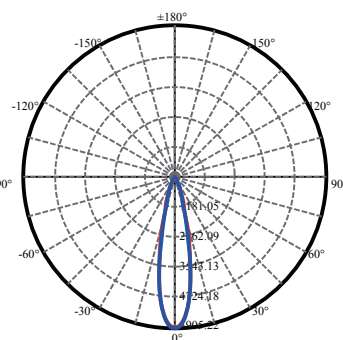

24 degree

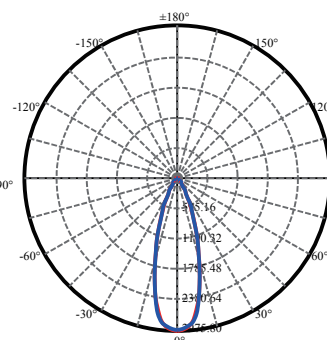

38 degree

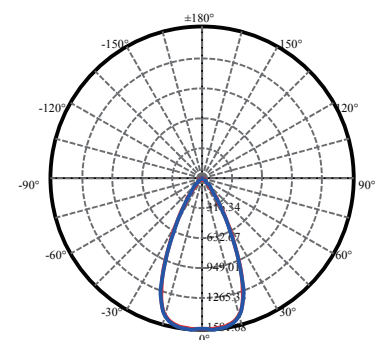

60 degree

PERFORMANCE DATA

LUMEN OUTPUT

Lumen values are estimated with LED data sheet.

Watts	Lumen Output	CRI	AC Input 120V	CCT	LPW
10	830	90	0.08A	3000K	83
15	1240	90	0.13A	3000K	83
22	2090	90	0.18A	3000K	95

Lumen Ambient Temperature (LAT) Multipliers

Use these factors to determine relative lumen output for average ambient temperature from -4-104° F (-20-40° C)

Ambient		Multiplier
Celsius	Fahrenheit	
0	32	1.06
10	50	1.03
20	68	1.01
25	77	1.00
30	86	0.99
40	104	0.97

TRACK SYSTEM COMPATIBILITY

Ref#: 20240222

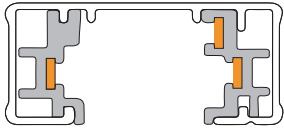
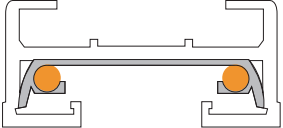
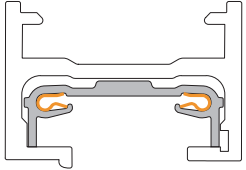
Track Style	H-Style	J-Style	L-Style
Track Rail			
Wire/Buss Bars	3 wires	2 wires	2 wires
Circuit	Single	Single	Single
Remark	<p>H type - operates on Halo Cooper Single Circuit track or Powergear track J type - operates on Juno Single or Dual Circuit Track System but works as single circuit track L type - operates on Lightolier Signify Single Circuit Track</p> <p>* Dural Circuit and 2C2N(Two-Circuit Two-Neutral) System is available as special requirement. Please contact Customer Service in advance.</p>		

BUG Rating

Performed to IESNA LM-79-08 standards by a NVLAP accredited laboratory

Model	BUG Rating	Model	BUG Rating
MCL10-30904-38	B3-U0-G2	MCL22-30904-15	B3-U0-G3
MCL15-30904-15	B3-U0-G2	MCL22-30904-24	B4-U0-G3
MCL15-30904-24	B3-U0-G2	MCL22-30904-38	B4-U0-G3
MCL15-30904-38	B3-U0-G1	MCL22-30904-60	B5-U0-G1

Warranty

Five year limited warranty.