

# 3.8" WIDE MAGIC LED LINEAR LIGHT

## Recessed Mount



### Family Product

Surface Mount



Suspended

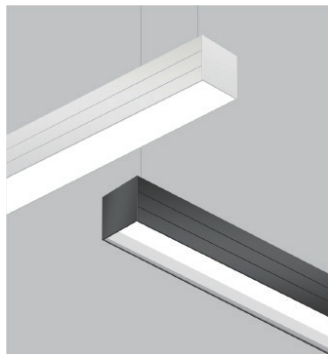

Please refer to <https://www.abovealllighting.com/> for family product details.



The Magic LED Linear Light is a sleek, 3.8-inch-wide architectural fixture designed for recessed mounting, featuring a slim profile ideal for discreet installations. Available in standard lengths of 2', 3', 4', and 8', it supports seamless joining for custom continuous runs. The Magic LED Linear Light delivers uniform illumination with selectable CCT(3000K/3500K/4000K). Optional illuminated joiners enable modular configurations for creative lighting designs.

## TECHNICAL DATA

<b>Length</b>	2ft, 3ft, 4ft, 8ft
<b>CRI</b>	80
<b>CCT</b>	Selectable 3000K/3500K/4000K
<b>Driver</b>	
Standard	0-10V Dimming, dim to 10%
Optional	0-10V Dimming, dim to 1%
<b>Compatible Dimmer</b>	LUTRON: DVSTV
	LEVITON: IP710
<b>Input Voltage</b>	120-277V, 50/60Hz
<b>Operating Temp.</b>	-4°F to 104°F(-20°C to 40°C)
<b>Certifications</b>	cULus conforms to UL Std. 1598
	Cert. to CSA Std. C22.2 No.250.0
	Suitable for damp locations
	RoHS compliant
<b>Power Factor</b>	>0.9 at full load
<b>Harmonic Distortion</b>	<20% at full load
<b>Projected Lifetime</b>	L70 - 100,000 Hours

## FEATURES

- **Adjustable & Customizable:** Dimmable with selectable CCT (3000K/3500K/4000K), delivering adaptable illumination for diverse environments. Lumen output up to 1200lm/ft. Flat lens & deep regressed lens options available.
- **Optional Add-ons:** Optional joiners including T-shape, L-shape, line, and cross configurations for unlimited creative lighting patterns. Microwave motion sensors and emergency battery backups available.

# 3.8" WIDE MAGIC LED LINEAR LIGHT

## Recessed Mount

### SPECIFICATION

#### Side View

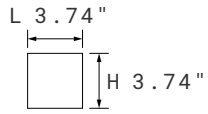

#### 2ft

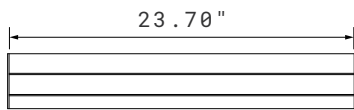

#### 3ft

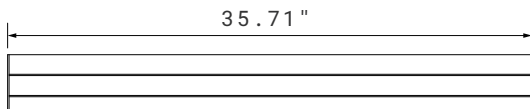

#### 4ft

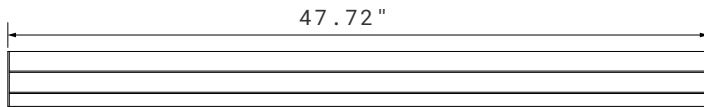

#### 8ft

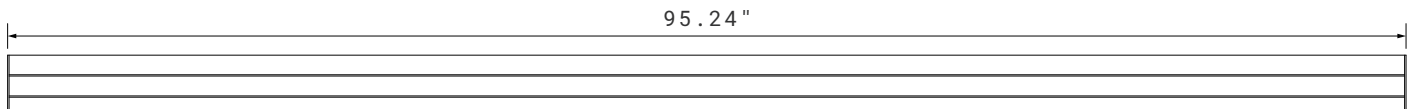

# 3.8" WIDE MAGIC LED LINEAR LIGHT

## Recessed Mount

### ORDERING INFORMATION

EXAMPLE: MAG1238-SW1-10D-RM-D-FDL

MAG					
1. Series	2. Length	3. Width	4. Driver	5. CCT	6. Voltage
MAG Magic	<b>06<sup>1</sup></b> 2ft Selectable 20W <sup>1</sup> /15W/10W  <b>09<sup>1</sup></b> 3ft Selectable 30W <sup>1</sup> /22.5W/15W  <b>12<sup>1</sup></b> 4ft Selectable 40W <sup>1</sup> /30W/20W  <b>24<sup>1</sup></b> 8ft Selectable 80W <sup>1</sup> /60W/40W  <b>Option<sup>2</sup></b> Desired System Length <sup>2</sup>	<b>38</b> 3.8 inch	<b>BLANK</b> Integral	<b>SW<sup>3</sup></b> Selectable 3000K 3500K 4000K <sup>3</sup>	<b>1</b> 120-277V
	7. Dimming	8. Mounting Options	9. Light Distribution	10. Lens Options	11. Finish
	<b>10D</b> Standard 0-10V Dimming, dim to 10%  <b>01D</b> Optional 0-10V Dimming, dim to 1%	<b>RM<sup>4</sup></b> Recessed Mounting  <i>Requires proper            mounting kits for            different ceiling            types.</i>	<b>D</b> 100% Downlight	<b>FDL<sup>5</sup></b> Flush Diffused Lens  <b>RGL<sup>5</sup></b> Regressed	<b>BLANK</b> White  <b>BK</b> Black

## ORDERING INFORMATION

### NOTE:

1. The default wattage setting is the highest available for each length: 20W for 2ft, 30W for 3ft, 40W for 4ft, 80W for 8ft.
2. Fixtures are supplied in nominal lengths to ensure uniform illumination across runs and configurations. If custom runs are required, please provide us with your specific requirements in advance. The factory can pre-assemble middle runs and end runs for simplified installation, or end users may modify standard individual fixtures into these configurations as needed.
3. The default CCT setting is 4000K.
4. Please specify mounting kits from the accessory table below for different ceiling types.
5. Please specify the Continuous Roll-Out Lens from the accessory table below for joined lengths exceeding 8ft.

## ACCESSORIES (ORDERED SEPARATELY AND FIELD INSTALLED)

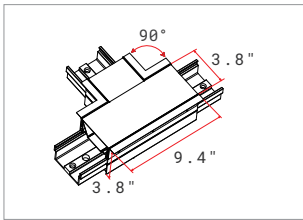

*Compatible with dry ceiling installations only.*

### MAG38-T

Illuminated T-Shape Joiner.

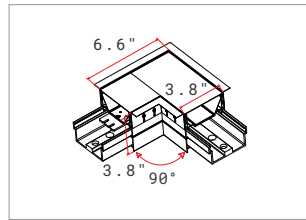

*Compatible with dry ceiling installations only.*

### MAG38-L

Illuminated 90° L-Shape Joiner.

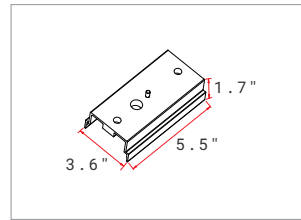

*Compatible with dry ceiling installations only.*

### MAG38-LINE

Illuminated Line Shape Joiner.

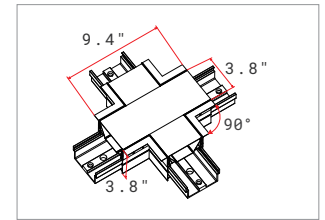

*Compatible with dry ceiling installations only.*

### MAG38-CROSS

Illuminated Cross Shape Joiner.



*Dry Ceiling Recessed, Trim+Bracket.*

### MAG0638-RMK-DY-TM-BKT

2ft, 3.8" Linear Recessed Mounting Kit for Dry Ceiling, Trim + Bracket.

### MAG0938-RMK-DY-TM-BKT

3ft, 3.8" Linear Recessed Mounting Kit for Dry Ceiling, Trim + Bracket.

### MAG1238-RMK-DY-TM-BKT

4ft, 3.8" Linear Recessed Mounting Kit for Dry Ceiling, Trim + Bracket.

2 sets of **MAG1238-RMK-DY-TM-BKT** are required for 8ft runs.



*Dry Ceiling Recessed, Trimless.*

### MAG0623/38-RMK-DY-TMS

2ft, 2.3"/3.8" Linear Recessed Mounting Kit for Dry Ceiling, Trimless.

### MAG0923/38-RMK-DY-TMS

3ft, 2.3"/3.8" Linear Recessed Mounting Kit for Dry Ceiling, Trimless.

### MAG1223/38-RMK-DY-TMS

4ft, 2.3"/3.8" Linear Recessed Mounting Kit for Dry Ceiling, Trimless.

2 sets of **MAG1223/38-RMK-DY-TMS** are required for 8ft runs.

# 3.8" WIDE MAGIC LED LINEAR LIGHT

## Recessed Mount

### ACCESSORIES (ORDERED SEPARATELY AND FIELD INSTALLED)

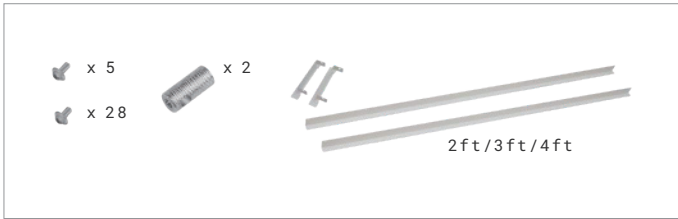

*Dry Ceiling/Drop Ceiling Recessed, Trim+Pendant Stem.*

#### **MAG0638-RMK-DY/DP-TM-STEM**

2ft, 3.8" Linear Recessed Mounting Kit for Dry Ceiling/Drop Ceiling, Trim + Pendant Stem.

#### **MAG0938-RMK-DY/DP-TM-STEM**

3ft, 3.8" Linear Recessed Mounting Kit for Dry Ceiling/Drop Ceiling, Trim + Pendant Stem.

#### **MAG1238-RMK-DY/DP-TM-STEM**

4ft, 3.8" Linear Recessed Mounting Kit for Dry Ceiling/Drop Ceiling, Trim + Pendant Stem. Specify 2 sets for 8ft runs.

2 sets of **MAG1238-RMK-DY/DP-TM-STEM** are required for 8ft runs.



*Drop Ceiling Recessed, Trimless+T-grid Hooks.*

#### **MAG23/38-RMK-DP-TMS**

2.3"/3.8" Magic Linear T-grid Recessed Mounting Kit for Drop Ceiling, Trimless.

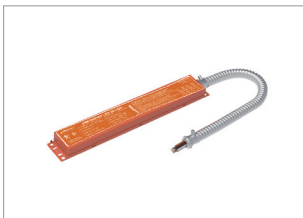

**AAL-EBU-AC08D-YYY<sup>2</sup>**  
Remote 8W LED Emergency  
Battery Back-up.  
120-347VAC.



**MAG38-ROL<sup>1</sup>**  
Continuous Roll-Out Lens  
(42').



**MAG-MSW-PM/SM**  
Microwave Motion Sensor  
Kit for Pendant Mounting.



**AAL-RC-100**  
Remote Control for  
Microwave Motion Sensor.

#### **AAL-EBU-AC25D-YYY<sup>2</sup>**

Remote 25W LED Emergency  
Battery Back-up.  
120-347VAC.

#### **NOTE:**

1. For joined lengths exceeding 8ft, only the Continuous Roll-Out Lens may be used.
2. The 8W EBU supports up to 60W total lighting load. The 25W EBU supports up to 150W total lighting load. The dimming control wire must be connected. The EBU is Title 20 compliant. Emergency battery backup operates within ambient temperatures of 32°F to 95°F (0°C to 35°C).

### PHOTOMETRY

All published luminaire photometric testing performed to IESNA LM-79-08 standards by a NVLAP certified laboratory. IESNA LM-79-08 specifies the entire luminaire as the source resulting in a fixture efficiency of 100%. Results may vary per actual order.

#### 2ft, Flat Lens, 4000K, 100% Downlight

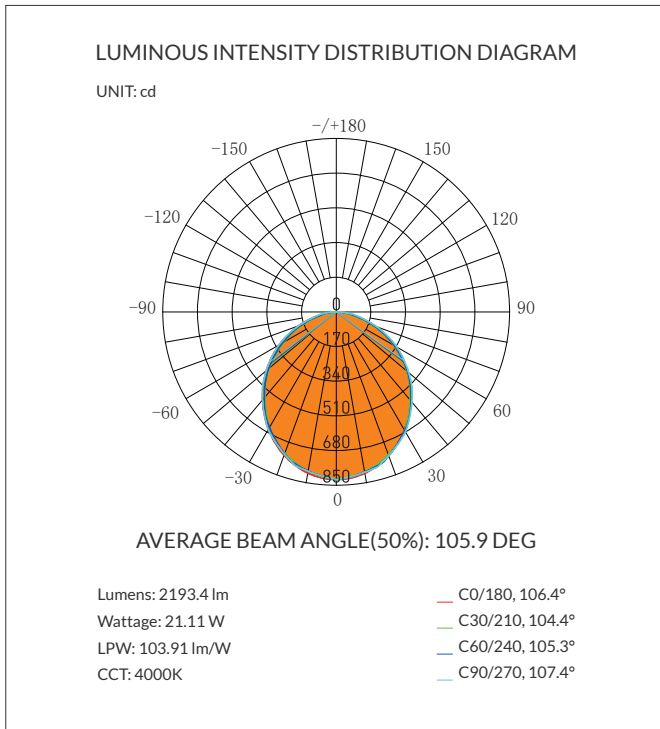

#### 4ft, Flat Lens, 4000K, 100% Downlight

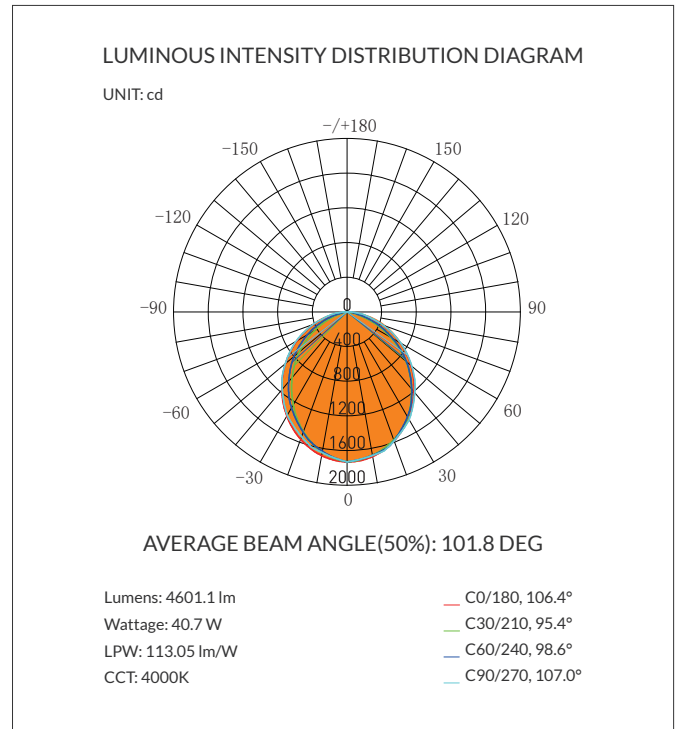

### PERFORMANCE DATA

Lumen values are measured by third party certified laboratories performed in accordance with IESNA LM-79-08 as well as Lighting Facts listed.

Optics	Length	100% Down@3500K		
		High	Medium	Low
Flat Lens	2ft, 3ft, 4ft, 8ft	1100lm/ft, 10W/ft	800lm/ft, 7.5W/ft	550lm/ft, 5W/ft
Regressed Lens	2ft, 3ft, 4ft, 8ft	900lm/ft, 10W/ft	670lm/ft, 7.5W/ft	450lm/ft, 5W/ft

#### NOTE:

- Above data are subject to 3500K, All efficacy is ±5% base on different CCT and lighting distributions. Please check the IES file to gain the accurate data. For 3000K fixtures, use 0.96 multiplier; for 4000K fixtures, use 1.04 multiplier.

### MICROWAVE DIMMING SENSOR SETTING (120-277V)

By selecting the combination on the DIP switch, sensor data can be precisely set for each specific application. The sensor setting also can be done by a remote control (RC-100) which need to be bought separately.

	1	2	
I	↓	↓	20%
II	↓	↑	50%
III	↑	↓	75%
IV	↑	↑	100%

#### Sensitivity

Sensitivity can be reduced by selecting the combination on the DIP switches to fit precisely each application.

**Default Setting: 100%**

	3	4	
I	↓	↓	10s
II	↓	↑	1min
III	↑	↓	5mins
IV	↑	↑	15mins

#### Hold time

Refers to the time period the lamp remains at 100% illumination after no motion detected.

**Default Setting: 15mins**

	5	6	
I	↓	↓	☀
II	↓	↑	10 lux
III	↑	↓	30 lux
IV	↑	↑	50 lux

#### Daylight sensor

The sensor can be set to only allow the lamp to illuminate below a defined ambient brightness threshold.

**Default Setting: ☀ (Disable)**

	7	8	
I	↓	↓	0%
II	↓	↑	10%
III	↑	↓	30%
IV	↑	↑	50%

#### Stand-by dimming level

The low light level you would like to have after the hold time in the long absence of people.

**Default Setting: 50%**

	9	10	
I	↓	↓	+∞
II	↓	↑	1min
III	↑	↓	30mins
IV	↑	↑	60mins

#### Stand-by time

Refers to the time period the lamp remains at a low light level before it completely switches off in the long absence of people. When set to “ +∞ ” mode, the low light is maintained until motion is detected.

**Default Setting: 30mins**

# 3.8" WIDE MAGIC LED LINEAR LIGHT

## Recessed Mount

### MOUNTING LOCATION

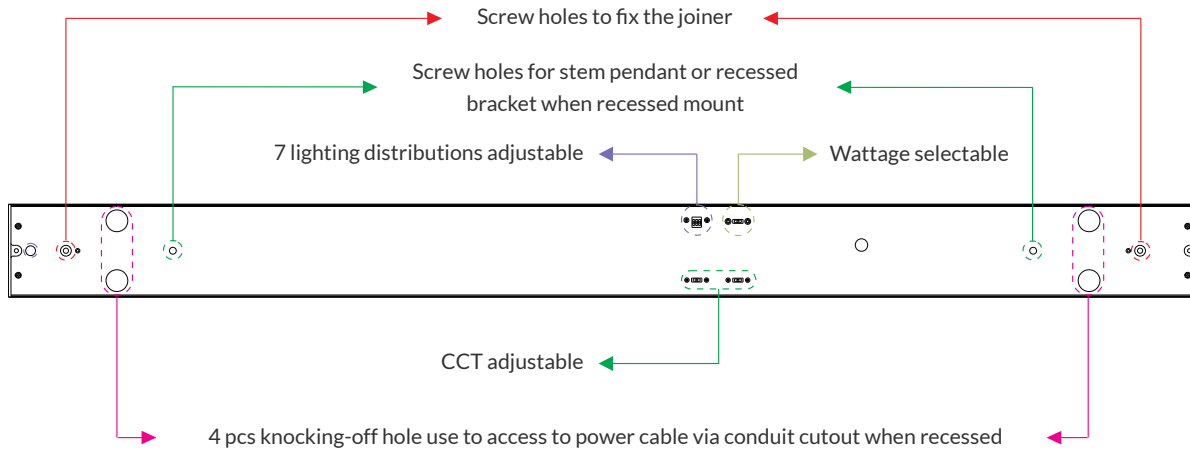

### RECESSED MOUNTING

#### Recessed in Grid Ceiling

##### T-Grid Hooks

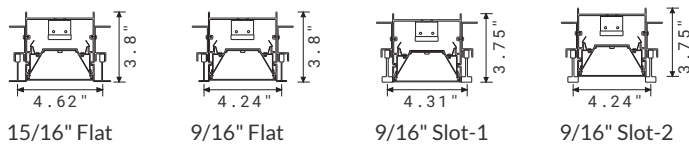
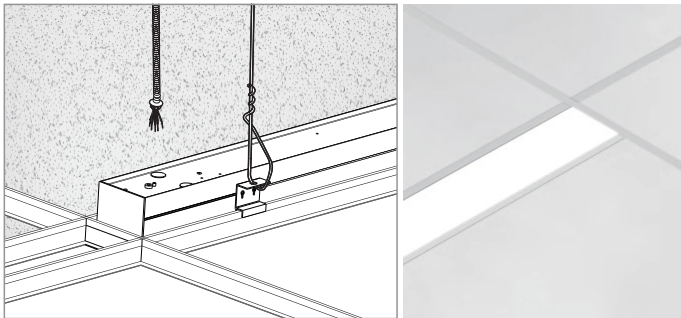

##### Flanged Trim

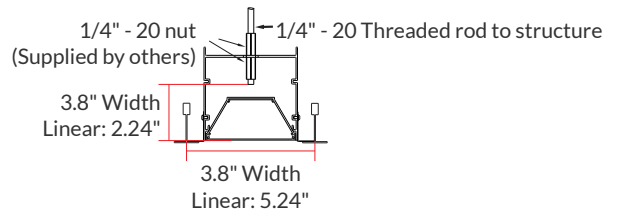
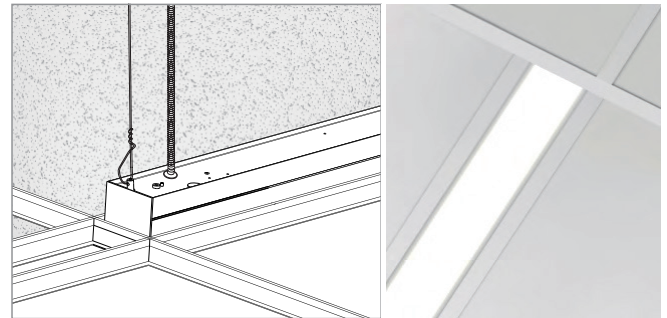

##### Mounting Kits



##### Mounting Kits



# 3.8" WIDE MAGIC LED LINEAR LIGHT

## Recessed Mount

### RECESSED MOUNTING

#### Recessed in Dry Ceiling

##### Trim (Recessed with Pendant Stem)

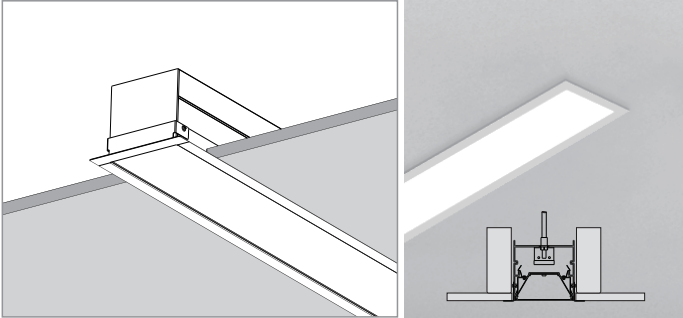

##### Mounting Kits



##### Trimless

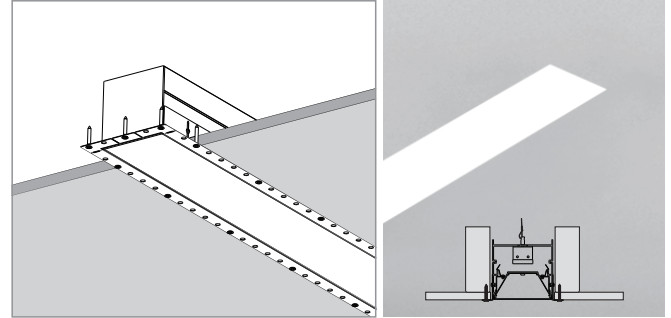

##### Mounting Kits



##### Trim (Recessed with Brackets)

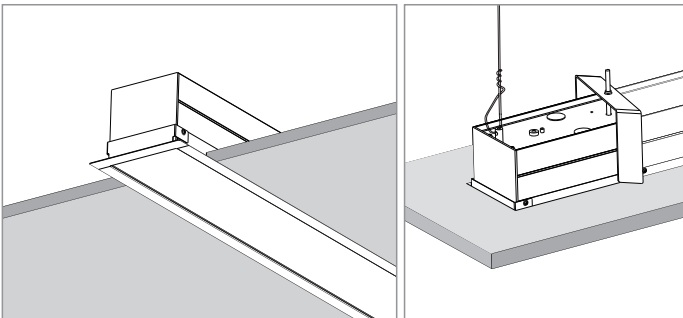

##### Mounting Kits



### WARRANTY

5 years limited warranty.

Specifications subject to change without notice.