



The ultimate in modern aesthetics. It isn't just about track rail, it's also about creating unique lighting configurations. Thanks to different types of corners, the geometrical possibilities really are endless. Even after installation, the MAG magnetic track rails mean you can change the lighting configuration whenever and however you want.

TECHNICAL DATA

Certifications	ETL listed
	RoHS compliant

Magnetic Track Profile

Material	Aluminum
Finish Color	RAL9004 Black/RAL 9003 White
Input Voltage	24VDC
Input Current	8A max.

Magnetic Track Light

CCT	2700K, 3000K, 3500K, 4000K
CRI	90Ra
Driver	Triac, 0/1-10V
Installation	Magnetic
Environment	Indoor

FEATURES

- **Versatile Project Adaptability:** Compatible with multiple magnetic lights, various beam angles, and wattages, supporting diverse application needs.
- **Precise Light Control:** Features 4 CCT, high CRI, and multiple dimming protocols for customized lighting effects.

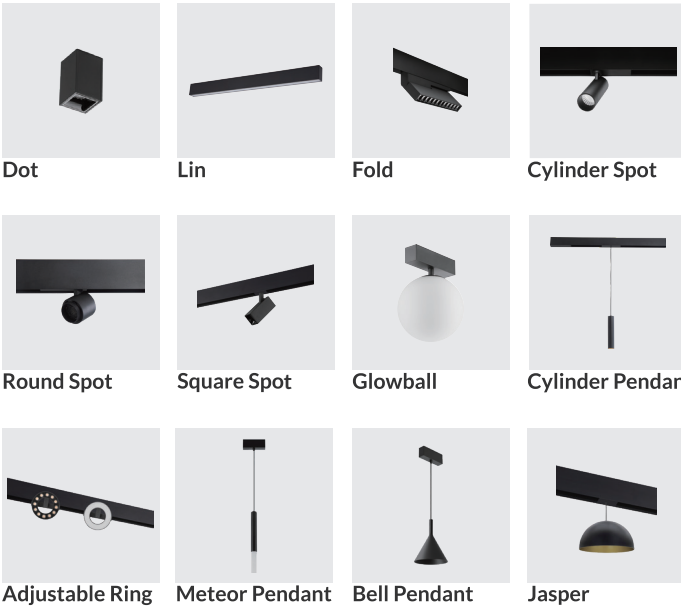

Dot Lin Fold Cylinder Spot

Round Spot Square Spot Glowball Cylinder Pendant

Adjustable Ring Meteor Pendant Bell Pendant Jasper

STRAIGHT MAGNETIC TRACK SYSTEM

Magnetic Track Profile



TECHNICAL DATA

Magnetic Track Profile

Material	Aluminum
Finish Color	RAL9004 Black/RAL 9003 White
Input Voltage	24VDC
Input Current	8A max.
Certifications	ETL listed RoHS compliant

PACKAGE INFORMATION

Item	Qty/Ctn (pcs)	N.W/Ctn (kgs/lbs)	G.W/Ctn (kgs/lbs)	LxWxH (cm/inch)
1 Meter Profile	6	10.8kgs/ 23.81lbs	12kgs/ 26.46lbs	105cmx21cmx20.5cm/ 41.34"x8.27"x8.07"
2 Meter Profile	6	21.6kgs/ 47.62lbs	23.5kgs/ 51.81lbs	205cmx21cmx20.5cm/ 80.71"x8.27"x8.07"
3 Meter Profile	3	16.2kgs/ 35.71lbs	18kgs/ 39.68lbs	305cmx21cmx20.5cm/ 120.08"x8.27"x8.07"



DIMENSION

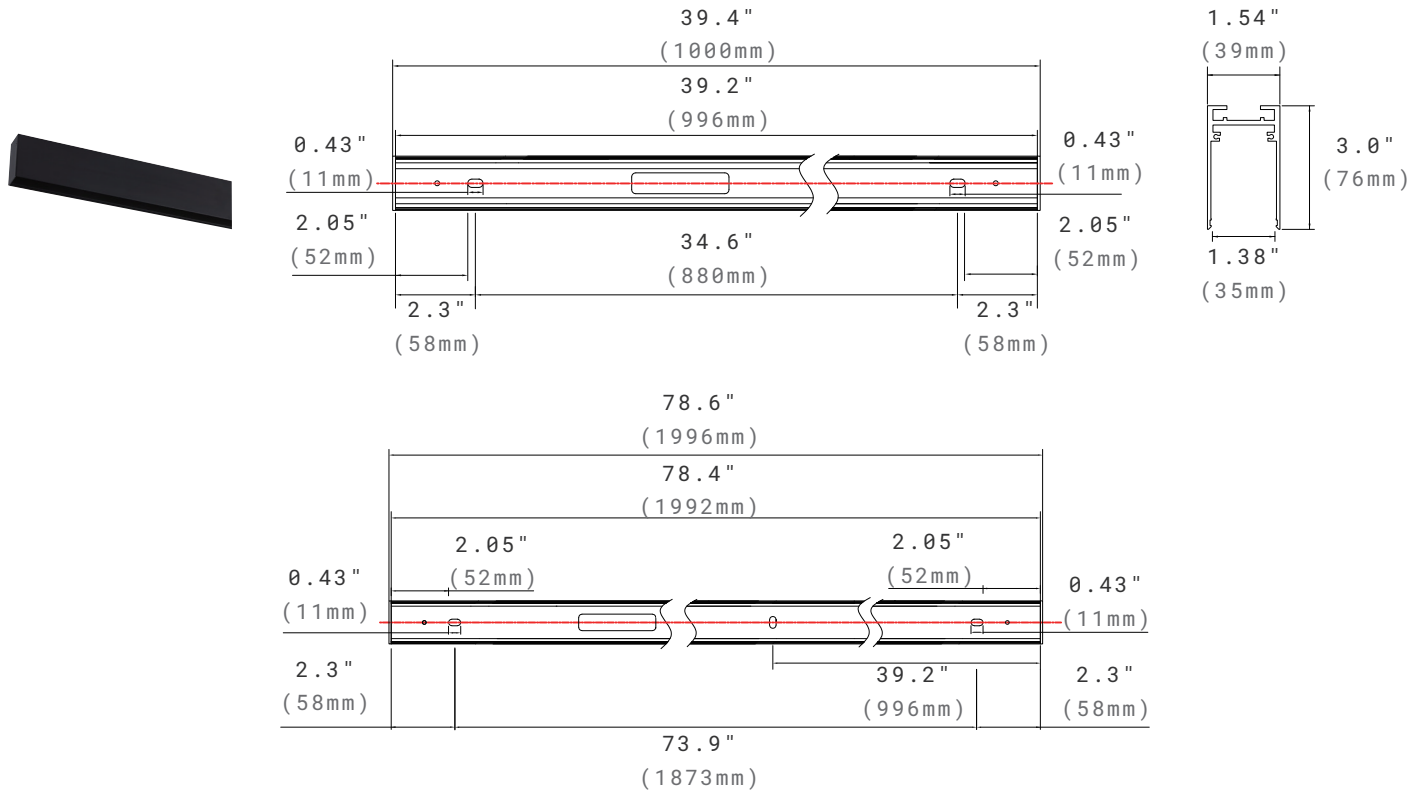

ORDERING INFORMATION

EXAMPLE: MTS1M-24V-BK

MTS					
Series	Length ¹	Voltage	Installation	Frame Finish	
MTS Magnetic Track Profile	1M 39"	24V ² 24VDC ²	Need to Order and Ship Separately ³	BK ⁴ Black ⁴ WH ⁴ White ⁴	
	2M 79"				PMK Pendant Mount Kits
	3M 118"				SMK Surface Mount Kits RMK Recessed Mount Kits

NOTE:

1. 39" (1M) and 79" (2M) profiles are standard. Customer needs pay the shipping cost for 118" (3M) profile. Custom track length is optional. If for special track length and pattern demand, please contact Customer Service. Continuous run mount can't exceed 1968.5" (50 meters), otherwise voltage drop will occur.
2. 24V constant voltage LED drivers can be chosen in the following driver list or supplied by customer. The total fixture wattages can't exceed 300W.
3. Different mounting kits need to be bought separately. Please check the details in the following accessory list.
4. Black and white finish is standard. Custom finish colors are available at an additional charge. Please contact Customer Service for premium options.



ACCESSORIES (ORDERED AND SHIPPED SEPARATELY)

CORNER

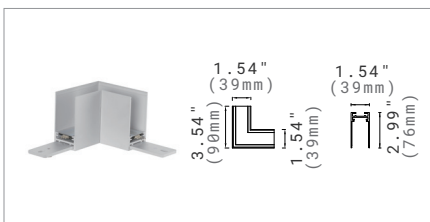
L Corner





MTS-LC-BK

Sandy Black 
 Sandy White 

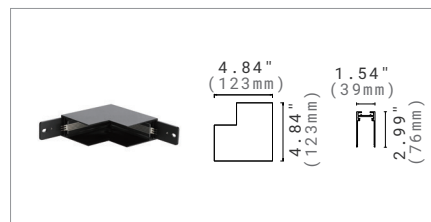
Inner Corner





MTS-IC-BK

Sandy Black 
 Sandy White 

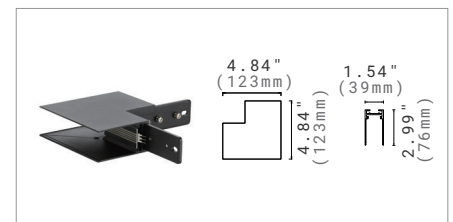
Outer Corner





MTS-OC-BK

Sandy Black 
 Sandy White 

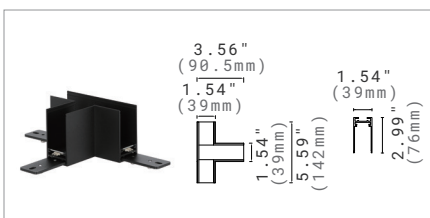
T Corner





MTS-TC-BK

Sandy Black 
 Sandy White 

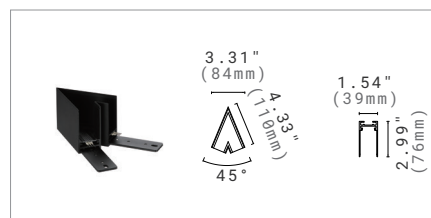
45D Corner



MTS-VC-BK

Sandy Black 
 Sandy White 

Cross Corner

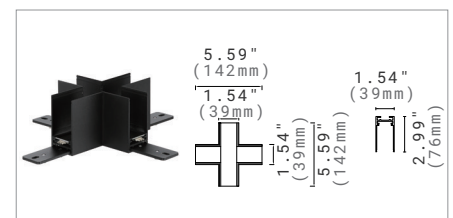

MTS-CC-BK

Sandy Black 
 Sandy White 

MOUNTING

Recessed Kits

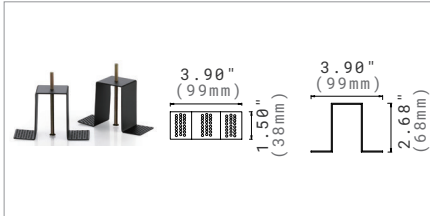

MTS-RM-BK

Recessed Mounting Kit for Magnetic Track

Sandy Black 

Sandy White 

*2 Pieces Per Set.

Pendant Kit-A

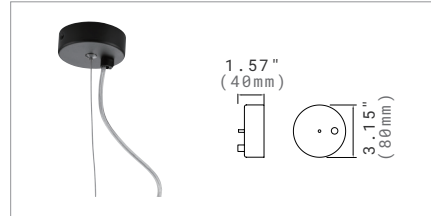

MTS-PM-A-BK

Suspension 47.2" (1.2meters) with Electrical Wire (1pc).

Sandy Black 

Sandy White 

Pendant Kit-B

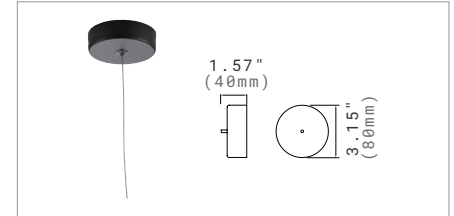

MTS-PM-B-BK

Suspension 47.2" (1.2meters) (1pc).

Sandy Black 

Sandy White 

Track Connector

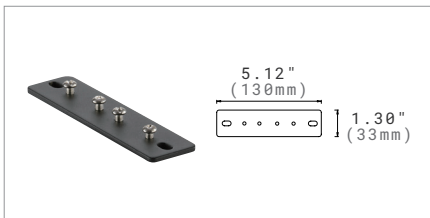

MTS-CNCT-BK

Profile Connection.

Sandy Black 

Sandy White 

*The Track Connector Must Be Worked Together with Power Plate.

Power Plate 2.56" (65mm)

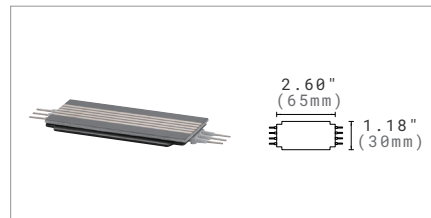

MTS-PP-65-BK

Electrical Connection, with 2 Pins.

Sandy Black 

Sandy White 

Surface Mount Kits



MTS-SM-BK

Surface Mounted for Magnetic Track, includes 4pcs.

Sandy Black 

Sandy White 

Track Cover

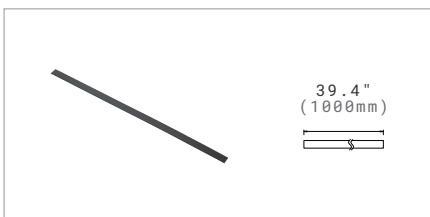

MTS-COVER-BK

Track Cover 1 Meter.

Sandy Black 

Sandy White 

Driver Box

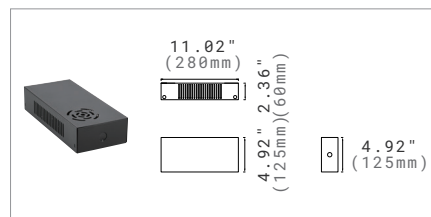

MTS-DBOX-BK

Empty Box.

Sandy Black 

Sandy White 

Track Bridge



MTS-TB-BK

Current: Max 8A,

Power: Max 200W.

Sandy Black 

Sandy White 

STRAIGHT MAGNETIC TRACK SYSTEM

Magnetic Track Profile Recessed with Flange



TECHNICAL DATA

Magnetic Track Profile Recessed with Flange

Material	Aluminum
Finish Color	RAL9004 Black/RAL 9003 White
Input Voltage	24VDC
Input Current	8A max.
Certifications	ETL listed RoHS compliant

PACKAGE INFORMATION

Item	Qty/Ctn (pcs)	N.W/Ctn (kgs/lbs)	G.W/Ctn (kgs/lbs)	LxWxH (cm/inch)
1 Meter Profile	6	11.7kgs/ 25.79lbs	12.6kgs/ 27.78lbs	105cmx36cmx22cm/ 41.34"x14.17"x8.66"
2 Meter Profile	6	23.4kgs/ 51.59lbs	24.1kgs/ 53.13lbs	205cmx36cmx22cm/ 80.71"x14.17"x8.66"
3 Meter Profile	3	17.4kgs/ 38.36lbs	19.2kgs/ 42.33lbs	305cmx36cmx22cm/ 120.08"x14.17"x8.66"



DIMENSION

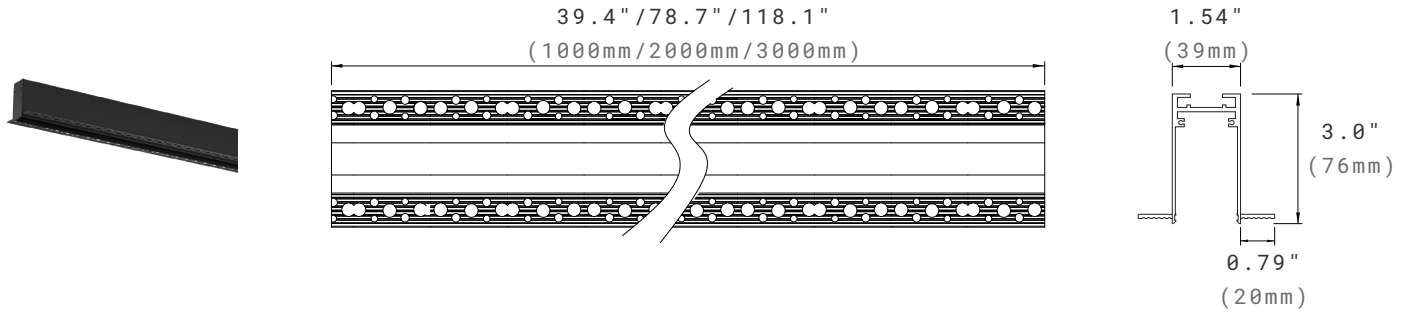

ORDERING INFORMATION

EXAMPLE: MTS-RF-1M-24V-BK

MTS-RF				
Series	Length ¹	Voltage	Installation	Frame Finish
MTS-RF Magnetic Track Profile Recessed with Flange	1M	24V ²	BLANK Recessed with Flange	BK ³
	39"	24VDC ²		Black ³
	2M			WH ³
	79"			White ³
	3M			
	118"			

NOTE:

1. Custom track length is optional. If for special track length and pattern demand, please contact Customer Service. Continuous run mount can't exceed 1968.5" (50 meters), otherwise voltage drop will occur.
2. 24V constant voltage LED drivers can be chosen in the following driver list or supplied by customer. The total fixture wattages can't exceed 300W.
3. Black and white finish is standard. Custom finish colors are available at an additional charge. Please contact Customer Service for premium options.



ACCESSORIES (ORDERED AND SHIPPED SEPARATELY)

CORNER

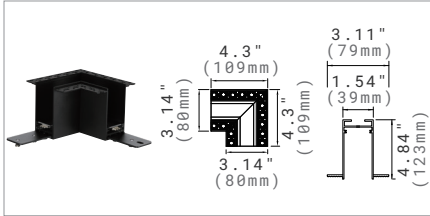
L Corner





MTS-RF-LC-BK

Sandy Black 
 Sandy White 

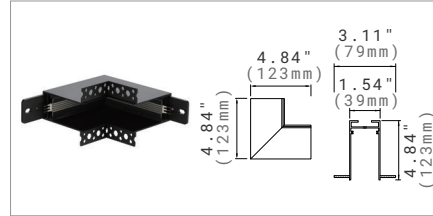
Inner Corner





MTS-RF-IC-BK

Sandy Black 
 Sandy White 

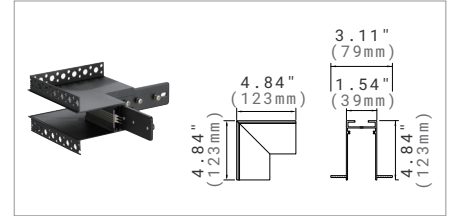
Outer Corner





MTS-RF-OC-BK

Sandy Black 
 Sandy White 

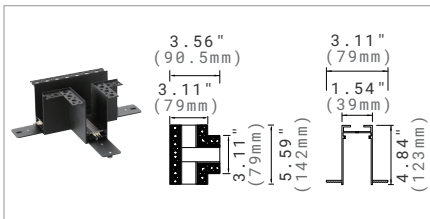
T Corner





MTS-RF-TC-BK

Sandy Black 
 Sandy White 

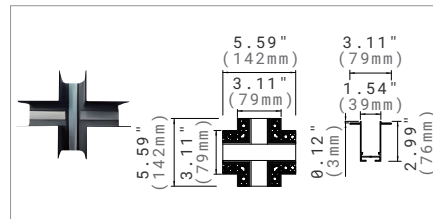
Cross Corner



MTS-RF-CC-BK

Sandy Black 
 Sandy White 

MOUNTING

Track Connector

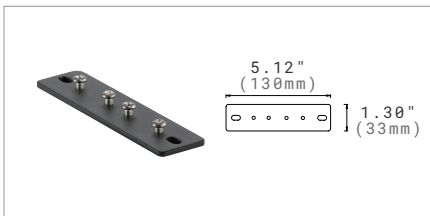

MTS-CNCT-BK

Profile Connection.
 Sandy Black 

Track Cover

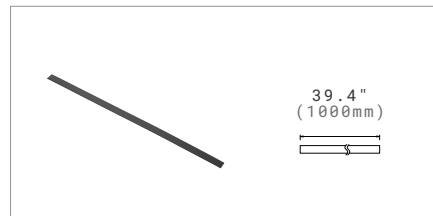

MTS-RF-COVER-BK

Track Cover 39.4" (1 meters).
 Sandy Black 

Driver Box

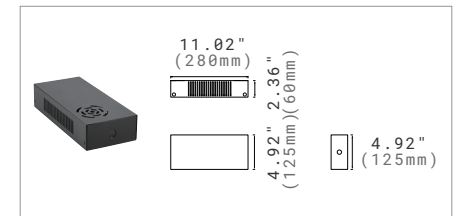

MTS-DBOX-BK

Empty Box.
 Sandy Black 

Track Bridge



MTS-TB-BK

Current: Max 8A,
Power: Max 200W.
Sandy Black 

CONSTANT VOLTAGE LED DRIVER LIST (ORDERED AND SHIPPED SEPARATELY)

5 IN 1 Dimmable LED Driver



KVG-24080-DWJ

80W,
Triac/0-10V/1-10V/10V
PWM.
Input Voltage: 120-277V.
Output Voltage: 24V DC.



KVG-24100-DWJ

100W,
Triac/0-10V/1-10V/10V
PWM.
Input Voltage: 120-277V.
Output Voltage: 24V DC.



KVG-24150-DWJ

150W,
Triac/0-10V/1-10V/10V
PWM.
Input Voltage: 120-277V.
Output Voltage: 24V DC.



KVG-24200-DWJ

200W,
Triac/0-10V/1-10V/10V
PWM.
Input Voltage: 120-277V.
Output Voltage: 24V DC.



KVG-24300-DWJ

300W,
Triac/0-10V/1-10V/10V
PWM.
Input Voltage: 120-277V.
Output Voltage: 24V DC.



LM-100-24-G1D2

100W,
DALI-2/Push DIM.
Size: 13.86"x1.69"x1.18".(LxWxH)
Input Voltage: AC120-277V.
Output Voltage: 24V DC.

STRAIGHT MAGNETIC TRACK SYSTEM

Track Light

DOT

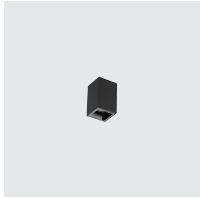

2W

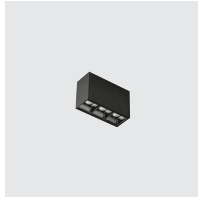

4W



8W



16W

LIN



4W

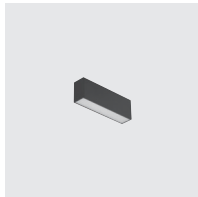

7W



13W



26W



39W

FOLD



4W Spot Lens



8W Spot Lens



16W Spot Lens

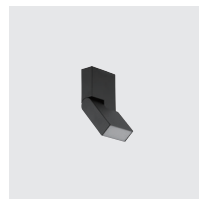

4W Diffused Lens

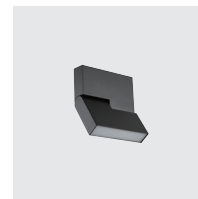

8W Diffused Lens



16W Diffused Lens

CYLINDER SPOT



5W

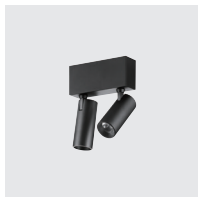

2x5W



10W



20W

ROUND SPOT



8W



15W

GLOWBALL



5W Surface Mount



5W Pendant Mount

CYLINDER PENDANT



5W



10W

METEOR PENDANT



5W (4")



5W (8")

ADJUSTABLE RING

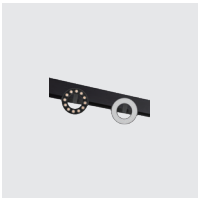

12W Spot Lens/
Diffused Lens

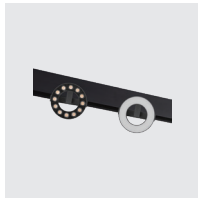

18W Spot Lens/
Diffused Lens

JASPER

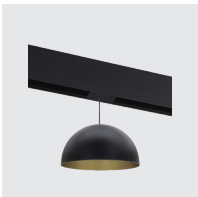

10W

BELL PENDANT



10W

SQUARE SPOT



10W

STRAIGHT MAGNETIC TRACK LIGHT

Dot Series



Magnetic Track Profile



Magnetic Track Profile
Recessed with Flange



The Dot Series is ideal for spot lighting. This design features a deep antiglare spot lens that allows for multiple beam angles, and is available in different wattages and lengths with elegant clean body.

TECHNICAL DATA

Wattage	2W, 4W, 8W, 16W
Input Voltage	24VDC
Beam Angle	12°, 34°, 48°
CCT	2700K, 3000K, 3500K, 4000K
CRI	90
Driver	Triac, 0/1-10V
Certifications	cETL Listed RoHS compliant
Installation	Magnetic
Environment	Indoor

NOTE:

Straight Magnetic Track Profile sold separately.

ORDERING INFORMATION

EXAMPLE: DOT04-3090-24V-34-MTM-BK

DOT Series	Wattage/Length	CCT&CRI	Voltage	Beam Angle	Installation	Finish
DOT	02 2W/1.34"	2790 2700K/90Ra	24V¹ 24VDC ¹	12 12 degree	MTM Magnetic Track Mount	BK³ Black ³
	04 4W/3.3"	3090 3000K/90Ra		34 34 degree		WH³ White ³
	08 8W/6.46"	3590 3500K/90Ra		48 48 degree		
	16 16W/12.76"	4090 4000K/90Ra				

NOTE:

1. The fixture is used for 24V magnetic track system.
2. Black and white finish is standard. Custom finish colors are available at an additional charge. Please contact Customer Service for premium options.

DIMENSION

2W

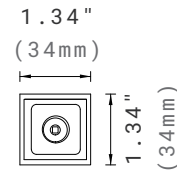
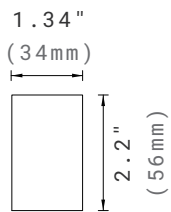
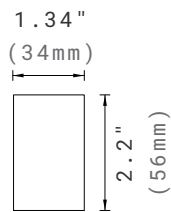

4W

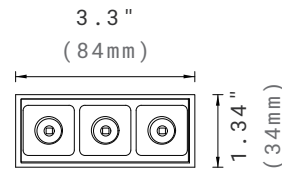
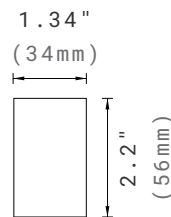
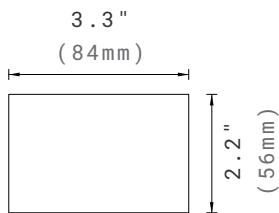

8W

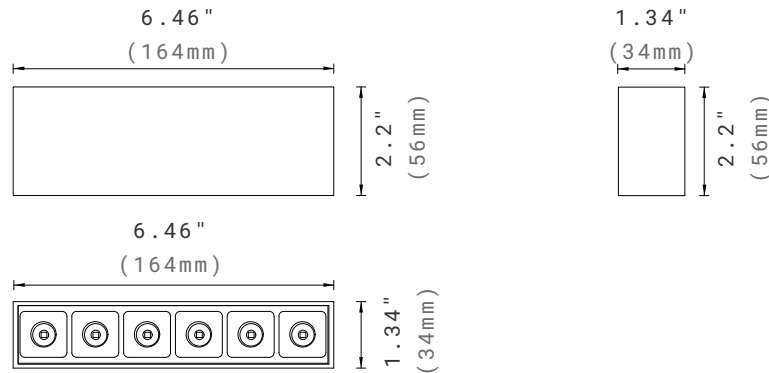

16W

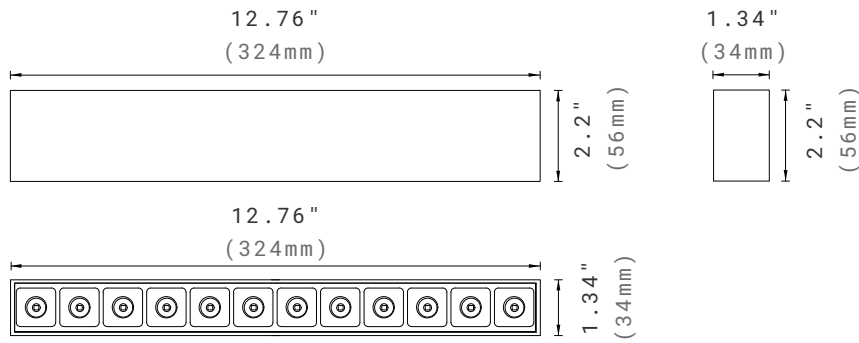

PHOTOMETRY

All published luminaire photometric testing performed to IESNA LM-79-08 standards by a NVLAP certified laboratory. IESNA LM-79-08 specifies the entire luminaire as the source resulting in a fixture efficiency of 100%. Results may vary per actual order.

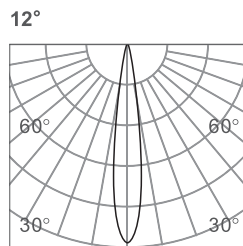

h(m)	E(lx)	Φ(m)
1	3693	Φ0.23
2	923	Φ0.47
3	410	Φ0.71
4	230	Φ0.94
5	147	Φ1.18

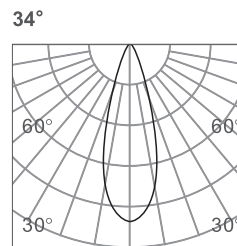

h(m)	E(lx)	Φ(m)
1	1238	Φ0.61
2	309	Φ1.22
3	137	Φ1.83
4	77	Φ2.44
5	49	Φ3.05

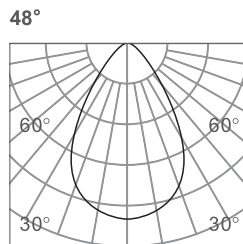

h(m)	E(lx)	Φ(m)
1	778	Φ0.91
2	194	Φ1.82
3	86	Φ2.73
4	48	Φ3.64
5	31	Φ4.55

PERFORMANCE DATA

Lumen values are measured by third party certified laboratories performed in accordance with IESNA LM-79-08 as well as Lighting Facts listed.

Wattage	Lumen Output	CRI	Beam Angle	CCT	LPW
2W	120lm	90	34°	3000K	60
4W	380lm	90	34°	3000K	95
8W	730lm	90	12°/34°/48°	3000K	92
16W	1430lm	90	12°/34°/48°	3000K	89



The Lin Series is a linear lighting solution designed to work with our Magnetic Track System. It features a low glare diffused lens and is available in several different wattage/length combinations all housed in an elegant body.

TECHNICAL DATA

Wattage	4W, 7W, 13W, 26W, 39W
Input Voltage	24VDC
CCT	2700K, 3000K, 3500K, 4000K
CRI	90Ra
Lens	Diffused
Driver	Triac, 0/1-10V
Certifications	cETL Listed RoHS compliant
Installation	Magnetic
Environment	Indoor



Magnetic Track Profile



Magnetic Track Profile
Recessed with Flange

NOTE:

Straight Magnetic Track Profile sold separately.

ORDERING INFORMATION

EXAMPLE: LIN04-3090-24V-DL-MTM-BK

LIN Series	Wattage/Length	CCT&CRI	Voltage	Lens	Installation	Finish
LIN	04 4W/3.3"	2790 2700K/90Ra	24V¹ 24VDC ¹	DL Diffused Lens	MTM Magnetic Track Mount	BK² Black ²
	07 7W/6.46"	3090 3000K/90Ra				WH² White ²
	13 13W/12.76"	3590 3500K/90Ra				
	26 26W/25.2"	4090 4000K/90Ra				
	39 39W/37.8"					

NOTE:

1. The fixture is used for 24V magnetic track system.
2. Black and white finish is standard. Custom finish colors are available at an additional charge. Please contact Customer Service for premium options.

DIMENSION

4W

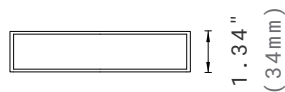
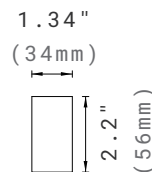
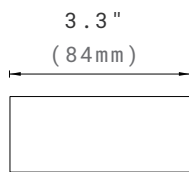

7W

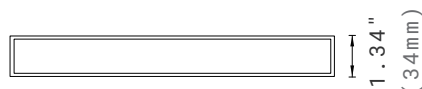
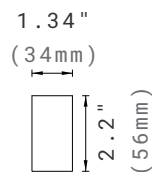
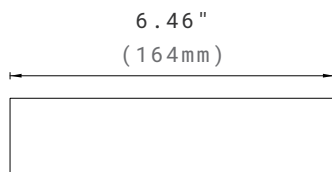

STRAIGHT MAGNETIC TRACK LIGHT

Lin Series

13W

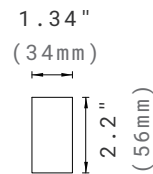
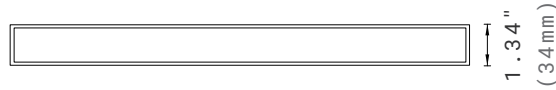
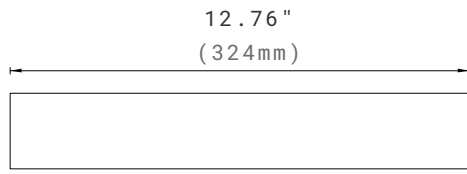

26W

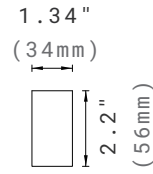
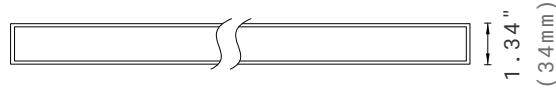
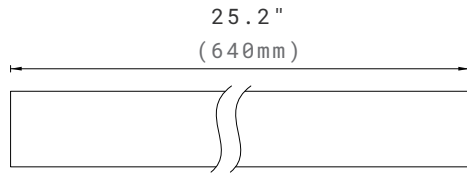

39W

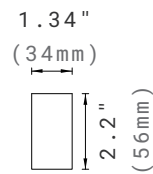
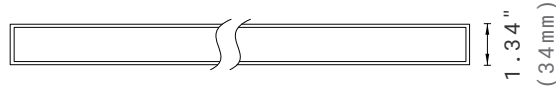
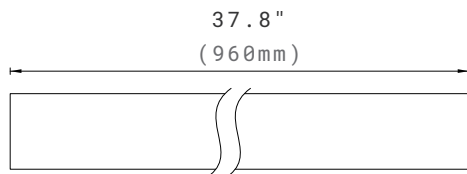

PHOTOMETRY

All published luminaire photometric testing performed to IESNA LM-79-08 standards by a NVLAP certified laboratory. IESNA LM-79-08 specifies the entire luminaire as the source resulting in a fixture efficiency of 100%. Results may vary per actual order.

Diffuse

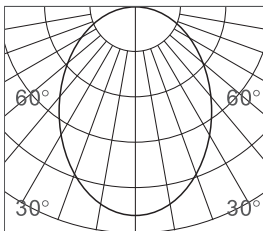

h(m)	E(lx)	Φ(m)
1	105.5	Φ2.60
2	26.3	Φ5.20
3	11.7	Φ7.80
4	6.5	Φ10.40
5	4.2	Φ13.00

PERFORMANCE DATA

Lumen values are measured by third party certified laboratories performed in accordance with IESNA LM-79-08 as well as Lighting Facts listed.

Wattage	Lumen Output	CRI	Lens	CCT	LPW
4W	220lm	90	Diffused	3000K	55
7W	490lm	90	Diffused	3000K	70
13W	900lm	90	Diffused	3000K	69
26W	1720lm	90	Diffused	3000K	66
39W	2550lm	90	Diffused	3000K	65

STRAIGHT MAGNETIC TRACK LIGHT

Fold



The Fold series can be used as a spotlight or a wall washer. The elegant design comes with either an antiglare spotlight lens which is available in several beam angles, or a soft diffused lens. The Fold series also features a adjustable head with 90° range of motion, and mounts on our 24V magnetic track system.

TECHNICAL DATA

Wattage	4W, 8W, 16W
Input Voltage	24VDC
Lens	12°, 34°, 48°, Diffused
CCT	2700K, 3000K, 3500K, 4000K
CRI	90Ra
Driver	Triac, 0/1-10V
Certifications	cETL Listed RoHS compliant
Installation	Magnetic
Environment	Indoor



4W with Spot Lens



8W with Spot Lens



16W with Spot Lens



4W with Diffused
Lens

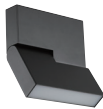

8W with Diffused
Lens



16W with Diffused
Lens

ORDERING INFORMATION

EXAMPLE: FOLD04-3090-24V-DL-MTM-BK

FOLD Series	Wattage	CCT&CRI	Voltage	Lens	Installation	Finish
FOLD	04 4W	2790 2700K/90Ra	24V ¹ 24VDC ¹	12 12 degree	MTM Magnetic Track Mount	BK ² Black ² WH ² White ²
	08 8W	3090 3000K/90Ra		34 34 degree		
	16 16W	3590 3500K/90Ra		48 48 degree		
		4090 4000K/90Ra		DL Diffused Lens		

NOTE:

1. The fixture is used for 24V magnetic track system.
2. Black and white finish is standard. Custom finish colors are available at an additional charge. Please contact Customer Service for premium options.

DIMENSION

4W



3.3"
(84mm)

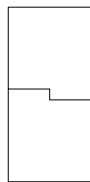

1.34"
(34mm)

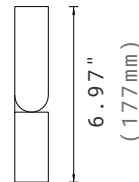

6.97"
(177mm)

8W



6.46"
(164mm)

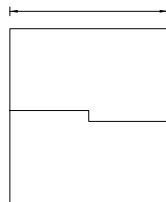

1.34"
(34mm)

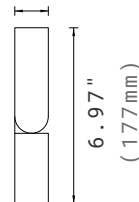

6.97"
(177mm)

STRAIGHT MAGNETIC TRACK LIGHT

Fold

16W

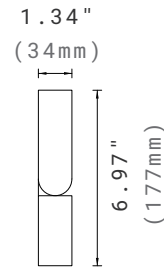
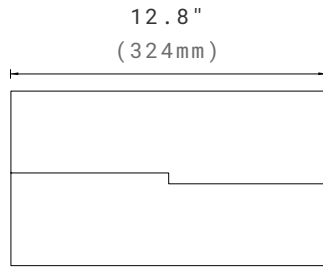

PHOTOMETRY

All published luminaire photometric testing performed to IESNA LM-79-08 standards by a NVLAP certified laboratory. IESNA LM-79-08 specifies the entire luminaire as the source resulting in a fixture efficiency of 100%. Results may vary per actual order.

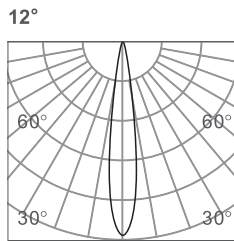

h(m)	E(lx)	Φ(m)
1	3693	Φ0.23
2	923	Φ0.47
3	410	Φ0.71
4	230	Φ0.94
5	147	Φ1.18

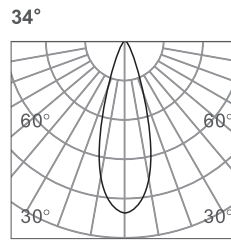

h(m)	E(lx)	Φ(m)
1	1238	Φ0.61
2	309	Φ1.22
3	137	Φ1.83
4	77	Φ2.44
5	49	Φ3.05

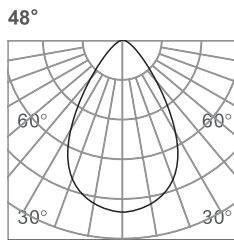

h(m)	E(lx)	Φ(m)
1	778	Φ0.91
2	194	Φ1.82
3	86	Φ2.73
4	48	Φ3.64
5	31	Φ4.55

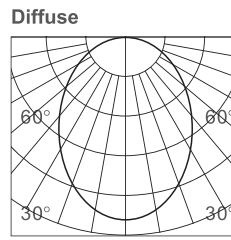

h(m)	E(lx)	Φ(m)
1	105.5	Φ2.60
2	26.3	Φ5.20
3	11.7	Φ7.80
4	6.5	Φ10.40
5	4.2	Φ13.00

PERFORMANCE DATA

Lumen values are measured by third party certified laboratories performed in accordance with IESNA LM-79-08 as well as Lighting Facts listed.

Wattage	Lumen Output	CRI	Lens	CCT	LPW
4W	380lm	90	12°/34°/48°	3000K	95
8W	790lm	90	12°/34°/48°	3000K	98
16W	1550lm	90	12°/34°/48°	3000K	97
4W	280lm	90	Diffused	3000K	70
8W	500lm	90	Diffused	3000K	63
16W	980lm	90	Diffused	3000K	61

STRAIGHT MAGNETIC TRACK LIGHT

Cylinder Spot



Two sizes with three different beam angles. Junction arm integrated in the spotlight's body to keep the barycentre aligned with the track. This junction arm allows 360° rotation in horizontal direction and 90° rotation in vertical direction.

TECHNICAL DATA

Wattage	5W, 2X5W, 10W, 20W
Input Voltage	24VDC
Beam Angle	
5W, 2X5W	20°, 30°, 40°
10W, 20W	18°, 24°, 36°
CCT	2700K, 3000K, 3500K, 4000K
CRI	90Ra
Driver	Triac, 0/1-10V
Certifications	cETL Listed RoHS compliant
Installation	Magnetic
Environment	Indoor



Small Spot 5W



Small Spot 2X5W



Medium Spot 10W



Large Spot 20W

ORDERING INFORMATION

EXAMPLE: CSS2X5-3090-24V-30-MTM-BK

CS							
Series	Size	Wattage	CCT&CRI	Voltage	Beam Angle	Installation	Finish
CS	S Small	5	2790	24V ¹	20	MTM Magnetic Track Mount	BK ² Black ² WH ² White ²
		5W	2700K/90Ra	24VDC ¹	20 degree		
		2X5	3090		30		
		2X5W	3000K/90Ra		30 degree		
		3590		40			
		3500K/90Ra		40 degree			
	M Medium	10	2790	24V ¹	18		
		10W	2700K/90Ra	24VDC ¹	18 degree		
	L Large	20	3090		24		
		20W	3000K/90Ra		24 degree		
			3590		36		
			3500K/90Ra		36 degree		
			4090				
			4000K/90Ra				

NOTE:

1. The fixture is used for 24V magnetic track system.
2. Black and white finish is standard. Custom finish colors are available at an additional charge. Please contact Customer Service for premium options.

STRAIGHT MAGNETIC TRACK LIGHT

Cylinder Spot

DIMENSION

Small Spot 5W

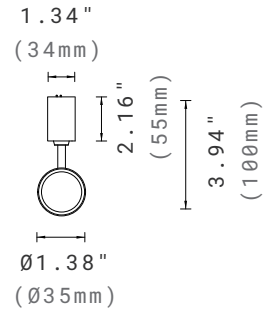
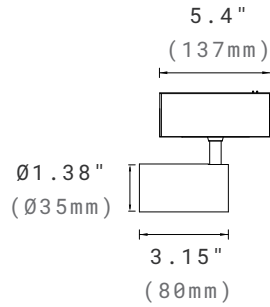

Small Spot 2X5W

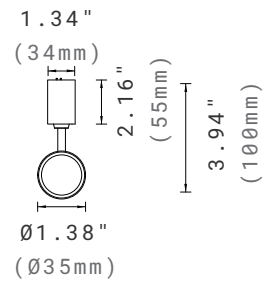
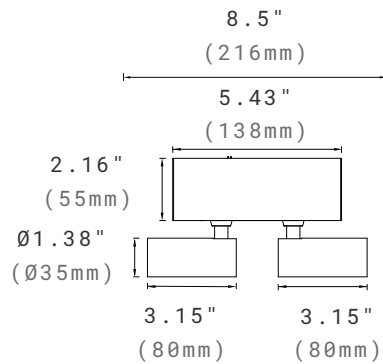

Medium Spot 10W

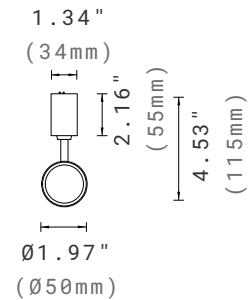
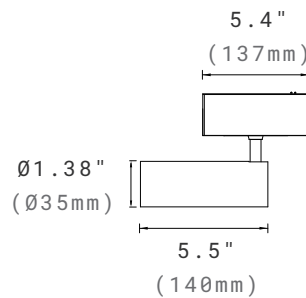

Large Spot 20W

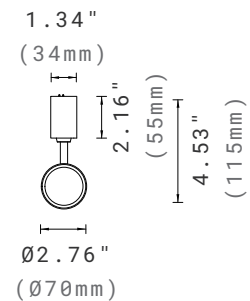
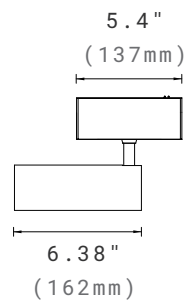

PHOTOMETRY

All published luminaire photometric testing performed to IESNA LM-79-08 standards by a NVLAP certified laboratory. IESNA LM-79-08 specifies the entire luminaire as the source resulting in a fixture efficiency of 100%. Results may vary per actual order.

Small Spot 5W, Small Spot 2X5W

20°

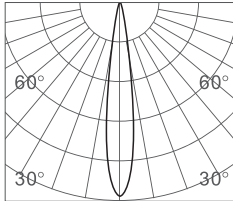

h(m)	E(lx)	Φ(m)
2	563	Φ0.69
3	250	Φ1.03
3.5	183	Φ1.20
4	140	Φ1.38
5	90	Φ1.55

30°

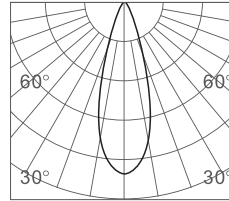

h(m)	E(lx)	Φ(m)
1	2519	Φ0.32
2	629	Φ0.65
3	279	Φ0.98
4	157	Φ1.31
5	100	Φ1.64

40°

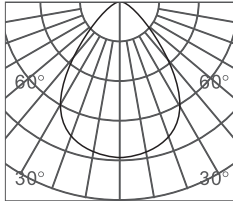

h(m)	E(lx)	Φ(m)
2	278	Φ0.96
3	124	Φ1.44
3.5	91	Φ1.68
4	69	Φ1.92
5	44	Φ2.40

Medium Spot 10W, Large Spot 10W

18°

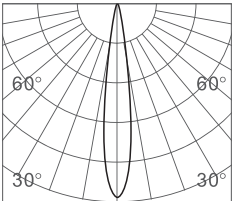

h(m)	E(lx)	Φ(m)
1	3011	Φ0.32
2	752	Φ0.64
3	334	Φ0.97
4	188	Φ1.29
5	120	Φ1.62

24°

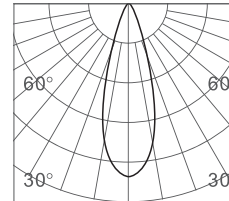

h(m)	E(lx)	Φ(m)
1	3857	Φ0.40
2	964	Φ0.81
3	428	Φ1.22
4	241	Φ1.62
5	154	Φ2.03

36°

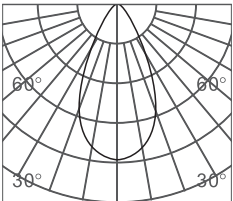

h(m)	E(lx)	Φ(m)
1	2154	Φ0.64
2	538	Φ1.28
3	239	Φ1.92
4	134	Φ2.56
5	86	Φ3.21

PERFORMANCE DATA

Lumen values are measured by third party certified laboratories performed in accordance with IESNA LM-79-08 as well as Lighting Facts listed.

Wattage	Beam Angle	Lumen Output	CRI	CCT	LPW
5W	20°/30°/40°	440lm	90	3000K	88
2X5W	20°/30°/40°	880lm	90	3000K	88
10W	18°/24°/36°	780lm	90	3000K	78
20W	18°/24°/36°	1450lm	90	3000K	72

STRAIGHT MAGNETIC TRACK LIGHT

Round Spot



Small Spot 8W



Large Spot 15W



The Round Spot series is available in two sizes and is designed to work with our Magnetic Track System. The junction arm is integrated in the Spots body, keeping the body centered on the track while allowing for 360° rotation along the horizontal plane and 90° rotation along the vertical plane. The fixture is available in three beam angles.

TECHNICAL DATA

Wattage	8W, 15W
Input Voltage	24VDC
Beam Angle	10°, 20°, 30°
CCT	2700K, 3000K, 3500K, 4000K
CRI	90Ra
Driver	Triac, 0/1-10V
Certifications	cETL Listed RoHS compliant
Installation	Magnetic
Environment	Indoor

ORDERING INFORMATION

EXAMPLE: RSS08-3090-24V-30-MTM-BK

RS Series	Size	Wattage	CCT&CRI	Voltage	Beam Angle	Installation	Finish
RS	S Small	08 8W	2790 2700K/90Ra 3090 3000K/90Ra	24V¹ 24VDC ¹	10 10 degree	MTM Magnetic Track Mount	BK² Black ²
	L Large	15 15W	3590 3500K/90Ra 4090 4000K/90Ra		20 20 degree 30 30 degree		WH² White ²

NOTE:

1. The fixture is used for 24V magnetic track system.
2. Black and white finish is standard. Custom finish colors are available at an additional charge. Please contact Customer Service for premium options.

DIMENSION

Small Spot 8W

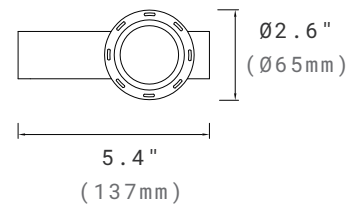
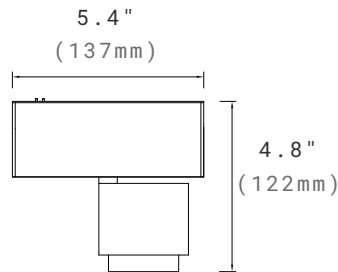

Large Spot 15W

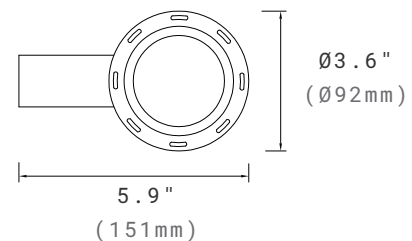
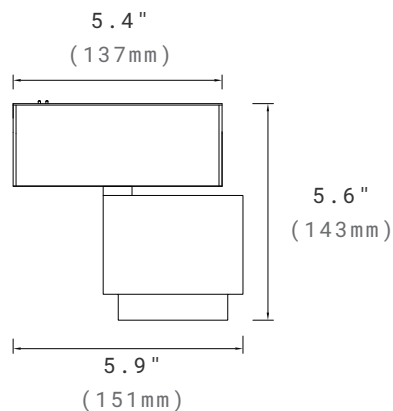

PHOTOMETRY

All published luminaire photometric testing performed to IESNA LM-79-08 standards by a NVLAP certified laboratory. IESNA LM-79-08 specifies the entire luminaire as the source resulting in a fixture efficiency of 100%. Results may vary per actual order.

10°

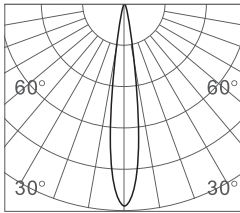

h(m)	E(lx)	Φ(m)
2	4203	Φ0.20
3	1051	Φ0.40
3.5	467	Φ0.61
4	262	Φ0.81
5	168	Φ1.02

20°

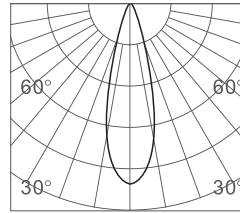

h(m)	E(lx)	Φ(m)
1	2675	Φ0.26
2	668	Φ0.53
3	297	Φ0.80
4	167	Φ1.06
5	107	Φ1.33

30°

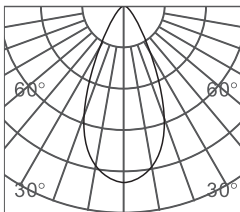

h(m)	E(lx)	Φ(m)
2	699	Φ0.53
3	174	Φ1.06
3.5	77	Φ1.60
4	43	Φ2.13
5	27	Φ2.66

PERFORMANCE DATA

Lumen values are measured by third party certified laboratories performed in accordance with IESNA LM-79-08 as well as Lighting Facts listed.

Wattage	Beam Angle	Lumen Output	CRI	CCT	LPW
8W	10°/20°/30°	400lm	90	3000K	50
15W	10°/20°/30°	900lm	90	3000K	60

STRAIGHT MAGNETIC TRACK LIGHT

Square Spot



Square shape with three different beam angles. The junction arm is integrated in the Spots body, keeping the body centered on the track while allowing for 360° rotation along the horizontal plane and 90° rotation along the vertical plane.

TECHNICAL DATA

Wattage	10W
Input Voltage	24VDC
Beam Angle	18°, 24°, 36°
CCT	2700K, 3000K, 3500K, 4000K
CRI	90Ra
Driver	Triac, 0/1-10V
Certifications	cETL Listed RoHS compliant
Installation	Magnetic
Environment	Indoor



Magnetic Track Profile



Magnetic Track Profile
Recessed with Flange

NOTE:

Straight Magnetic Track Profile sold separately.

ORDERING INFORMATION

EXAMPLE: SS10-3090-24V-24-MTM-BK

SS Series	Wattage	CCT&CRI	Voltage	Beam Angle	Installation	Finish
SS	10 10W	2790 2700K/90Ra 3090 3000K/90Ra 3590 3500K/90Ra 4090 4000K/90Ra	24V ¹ 24VDC ¹	18 18 degree 24 24 degree 36 36 degree	MTM Magnetic Track Mount	BK ² Black ² WH ² White ²

NOTE:

1. The fixture is used for 24V magnetic track system.
2. Black and white finish is standard. Custom finish colors are available at an additional charge. Please contact Customer Service for premium options.

DIMENSION

10W

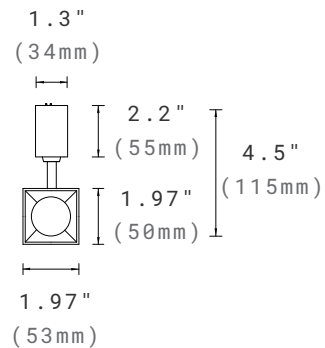
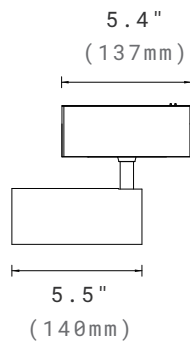

PHOTOMETRY

All published luminaire photometric testing performed to IESNA LM-79-08 standards by a NVLAP certified laboratory. IESNA LM-79-08 specifies the entire luminaire as the source resulting in a fixture efficiency of 100%. Results may vary per actual order.

18°

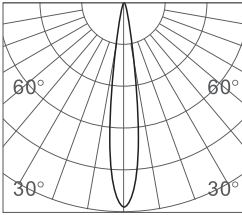

h(m)	E(lx)	Φ(m)
1	3011	Φ0.32
2	752	Φ0.64
3	334	Φ0.97
4	188	Φ1.29
5	120	Φ1.62

24°

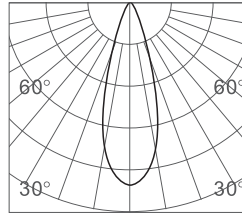

h(m)	E(lx)	Φ(m)
1	3857	Φ0.40
2	964	Φ0.81
3	428	Φ1.22
4	241	Φ1.62
5	154	Φ2.03

36°

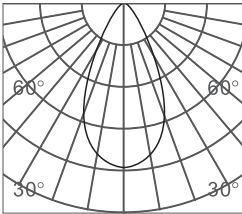

h(m)	E(lx)	Φ(m)
1	2154	Φ0.64
2	538	Φ1.28
3	239	Φ1.92
4	134	Φ2.56
5	86	Φ3.21

PERFORMANCE DATA

Lumen values are measured by third party certified laboratories performed in accordance with IESNA LM-79-08 as well as Lighting Facts listed.

Wattage	Beam Angle	Lumen Output	CRI	CCT	LPW
10W	18°/24°/36°	600lm	90	3000K	60



Our Glowball Series Magnetic Track Light is designed for decorative and general lighting. The diffuse spherical glass lens yields a smooth uniform light output, and the fixture is available as both a pendant or surface mounted to our 24V magnetic track system.

TECHNICAL DATA

Wattage	5W
Input Voltage	24VDC
Lens	Diffused
CCT	2700K, 3000K, 3500K, 4000K
CRI	90Ra
Driver	Triac, 0/1-10V
Certifications	cETL Listed RoHS compliant
Installation	Magnetic
Environment	Indoor



5W Surface Mount



5W Pendant Mount

ORDERING INFORMATION

EXAMPLE: GBL05-3090-24V-SM-BK

GBL Series	Wattage	CCT&CRI	Voltage	Lens	Installation	Finish
GBL	05 5W	2790 2700K/90Ra 3090 3000K/90Ra 3590 3500K/90Ra 4090 4000K/90Ra	24V ¹ 24VDC ¹	BLANK Diffused	SM Surface Magnetic Track Mount PM Pendant Magnetic Track Mount	BK ² Black ² WH ² White ²

NOTE:

1. The fixture is used for 24V magnetic track system.
2. Black and white finish is standard. Custom finish colors are available at an additional charge. Please contact Customer Service for premium options.

DIMENSION

5W Surface Mount

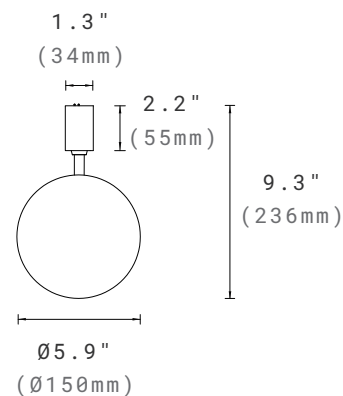
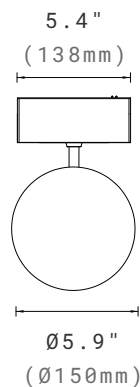

5W Pendant Mount

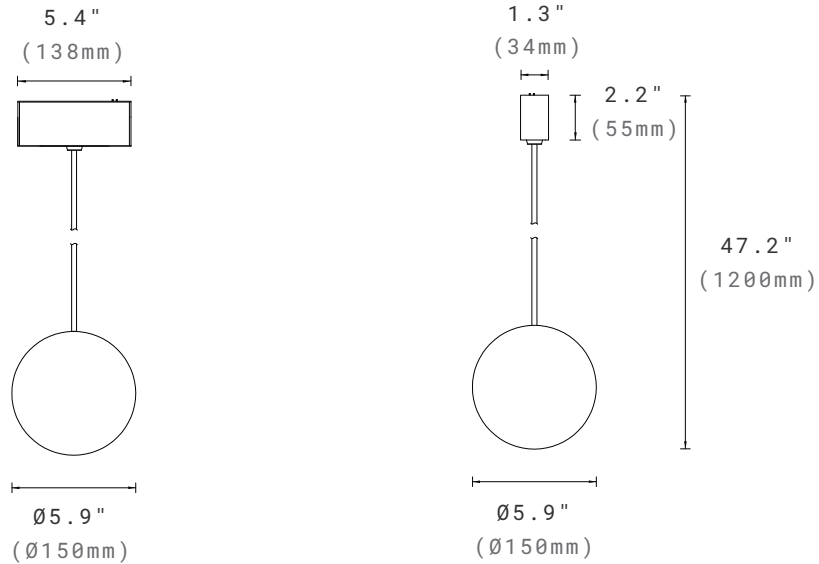

PHOTOMETRY

All published luminaire photometric testing performed to IESNA LM-79-08 standards by a NVLAP certified laboratory. IESNA LM-79-08 specifies the entire luminaire as the source resulting in a fixture efficiency of 100%. Results may vary per actual order.

2700K 80Ra

Diffuse

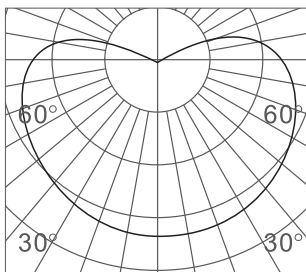

h(m)	E(lx)	Φ(m)
1	24	Φ2
2	6	Φ4
3	2	Φ6
4	1	Φ8
5	0.9	Φ10

PERFORMANCE DATA

Lumen values are measured by third party certified laboratories performed in accordance with IESNA LM-79-08 as well as Lighting Facts listed.

Wattage	Lens	Lumen Output	CRI	CCT	LPW
5W	Diffused	290lm	90	3000K	58

STRAIGHT MAGNETIC TRACK LIGHT

Cylinder Pendant



Elegant body coating and antiglare cover. Thanks to the length adjustable cable, the magnetic pendant works smooth in different spaces. Comfortable lighting without glare. Minimal glare and multiple light beams.

TECHNICAL DATA

Wattage	5W, 10W
Input Voltage	24VDC
Beam Angle	
5W	20°, 30°, 40°
10W	18°, 24°, 36°
CCT	2700K, 3000K, 3500K, 4000K
CRI	90Ra
Driver	Triac, 0/1-10V
Certifications	cETL Listed RoHS compliant
Installation	Magnetic
Environment	Indoor



5W



10W

STRAIGHT MAGNETIC TRACK LIGHT

Cylinder Pendant

ORDERING INFORMATION

EXAMPLE: CYLP05-3090-24V-30-MTM-BK

CYLP Series	Wattage	CCT&CRI	Voltage	Beam Angle	Installation	Finish
CYLP	05 5W	2790 2700K/90Ra 3090 3000K/90Ra 3590 3500K/90Ra 4090 4000K/90Ra	24V ¹ 24VDC ¹	20 20 degree 30 30 degree 40 40 degree	MTM Magnetic Track Mount	BK ² Black ² WH ² White ²
	10 10W	2790 2700K/90Ra 3090 3000K/90Ra 3590 3500K/90Ra 4090 4000K/90Ra	24V ¹ 24VDC ¹	18 18 degree 24 24 degree 36 36 degree		

NOTE:

1. The fixture is used for 24V magnetic track system.
2. Black and white finish is standard. Custom finish colors are available at an additional charge. Please contact Customer Service for premium options.

DIMENSION

Small 5W

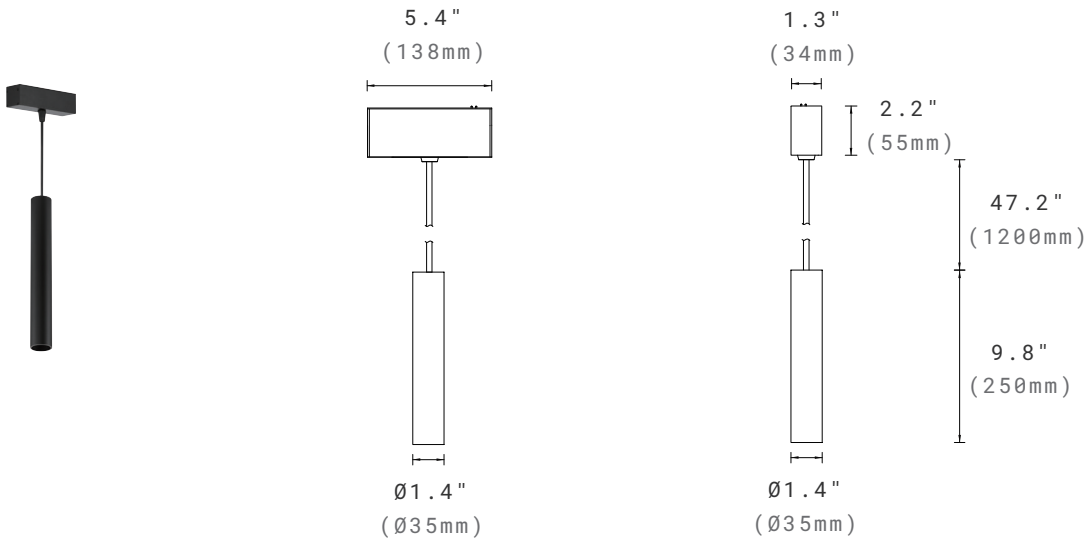

Large 10W

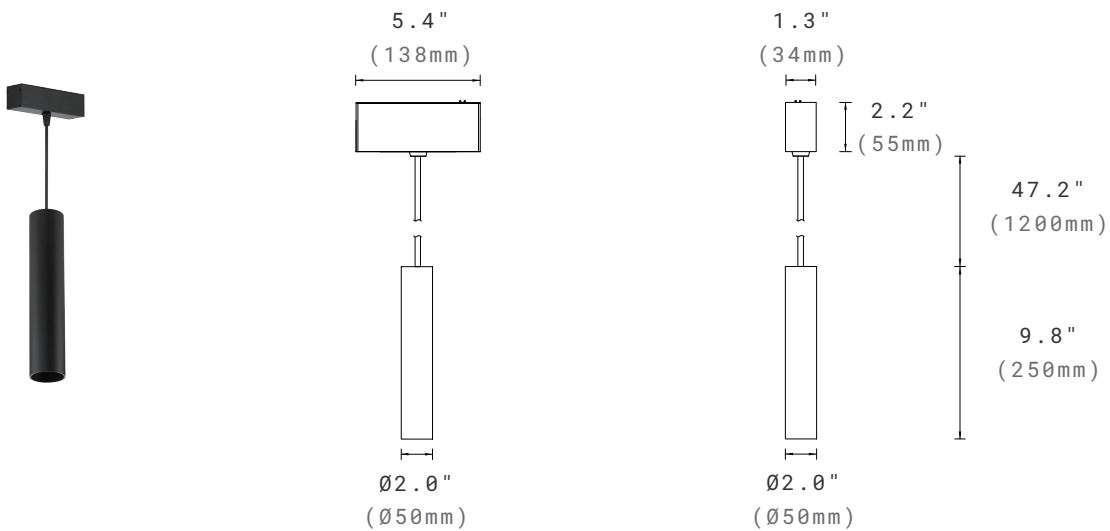

PERFORMANCE DATA

Lumen values are measured by third party certified laboratories performed in accordance with IESNA LM-79-08 as well as Lighting Facts listed.

Wattage	Beam Angle	Lumen Output	CRI	CCT	LPW
5W	20°/30°/40°	440lm	90	3000K	88
10W	18°/24°/36°	780lm	90	3000K	78

PHOTOMETRY

All published luminaire photometric testing performed to IESNA LM-79-08 standards by a NVLAP certified laboratory. IESNA LM-79-08 specifies the entire luminaire as the source resulting in a fixture efficiency of 100%. Results may vary per actual order.

Small 5W

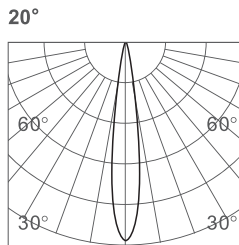

h(m)	E(lx)	Φ(m)
2	563	Φ0.69
3	250	Φ1.03
3.5	183	Φ1.20
4	140	Φ1.38
5	90	Φ1.55

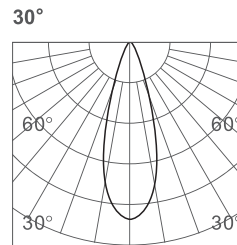

h(m)	E(lx)	Φ(m)
1	2519	Φ0.32
2	629	Φ0.65
3	279	Φ0.98
4	157	Φ1.31
5	100	Φ1.64

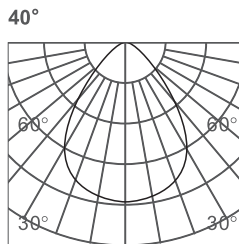

h(m)	E(lx)	Φ(m)
2	278	Φ0.96
3	124	Φ1.44
3.5	91	Φ1.68
4	69	Φ1.92
5	44	Φ2.40

Large 10W

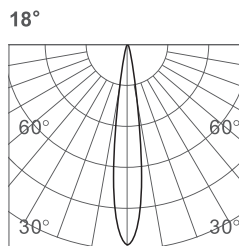

h(m)	E(lx)	Φ(m)
1	3011	Φ0.32
2	752	Φ0.64
3	334	Φ0.97
4	188	Φ1.29
5	120	Φ1.62

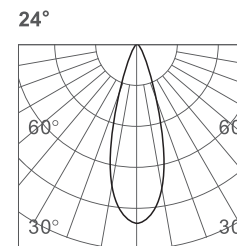

h(m)	E(lx)	Φ(m)
1	3857	Φ0.40
2	964	Φ0.81
3	428	Φ1.22
4	241	Φ1.62
5	154	Φ2.03

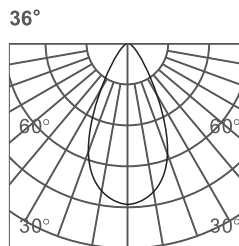

h(m)	E(lx)	Φ(m)
1	2154	Φ0.64
2	538	Φ1.28
3	239	Φ1.92
4	134	Φ2.56
5	86	Φ3.21

STRAIGHT MAGNETIC TRACK LIGHT

Adjustable Ring

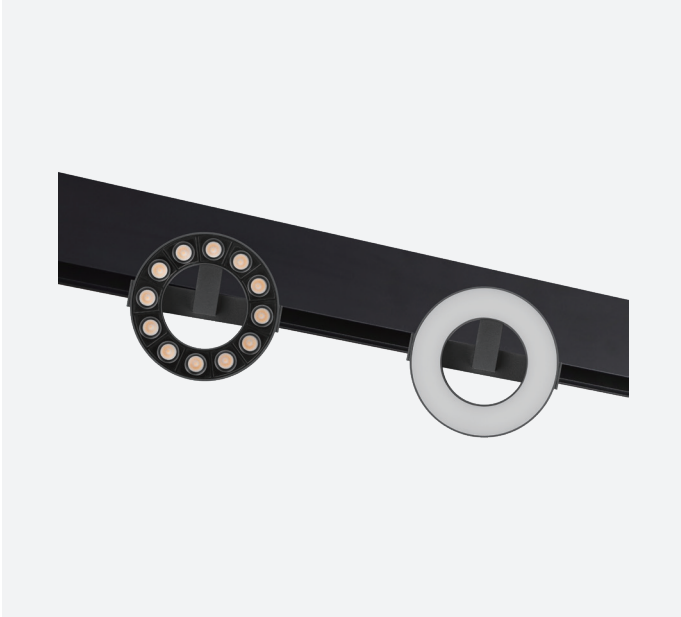

With Spot Lens



With Diffused Lens



90 degree foldable and elegant circle design. Three different anti-glare spot lens and diffused glare lens to achieve multiple light beams.

TECHNICAL DATA

Wattage	12W, 18W
Input Voltage	24VDC
Lens	20°, 34°, 48°, Diffused
CCT	2700K, 3000K, 3500K, 4000K
CRI	90Ra
Driver	Triac, 0/1-10V
Certifications	cETL Listed RoHS compliant
Installation	Magnetic
Environment	Indoor

ORDERING INFORMATION

EXAMPLE: ADJR18-3090-24V-34-MTM-BK

ADJR Series	Wattage	CCT&CRI	Voltage	Lens	Installation	Finish
ADJR	12 12W	2790 2700K/90Ra	24V ¹ 24VDC ¹	20 20 degree	MTM Magnetic Track Mount	BK ² Black ²
	18 18W	3090 3000K/90Ra		34 34 degree		WH ² White ²
		3590 3500K/90Ra		48 48 degree		
		4090 4000K/90Ra		DL Diffused Lens		

NOTE:

1. The fixture is used for 24V magnetic track system.
2. Black and white finish is standard. Custom finish colors are available at an additional charge. Please contact Customer Service for premium options.

DIMENSION

12W with Spot Lens

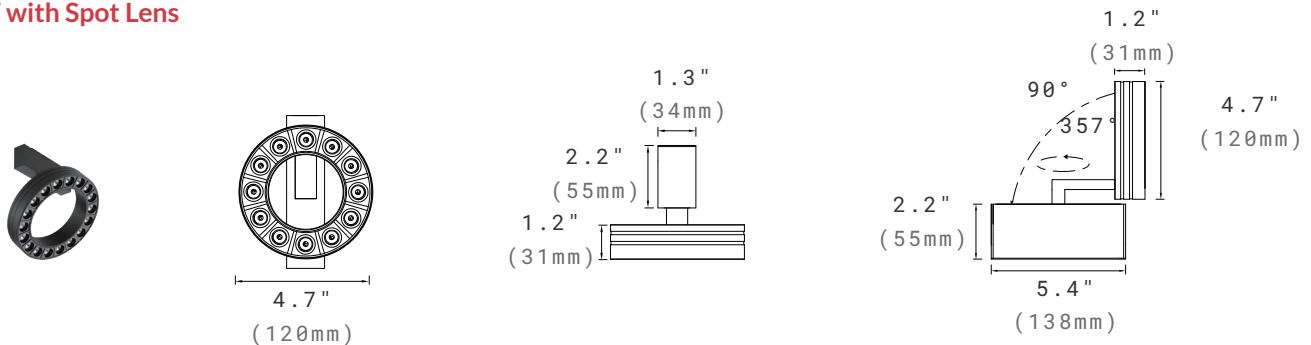

12W with Diffused Lens

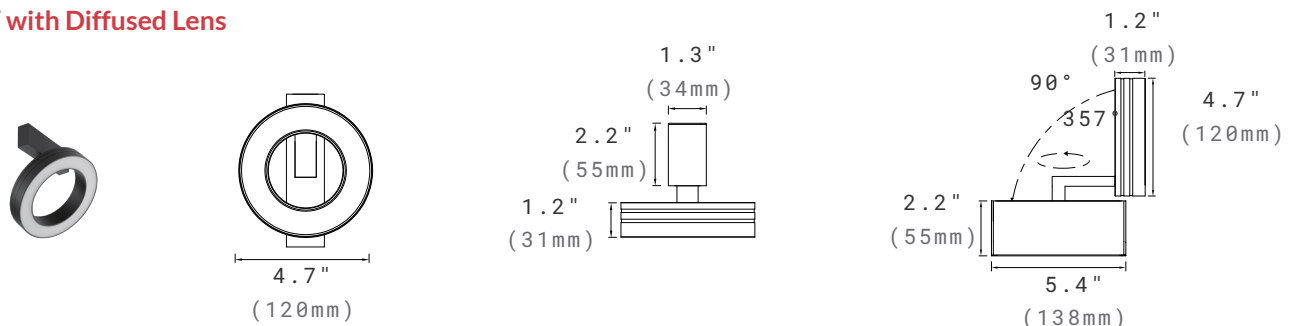

STRAIGHT MAGNETIC TRACK LIGHT

Adjustable Ring

18W with Spot Lens

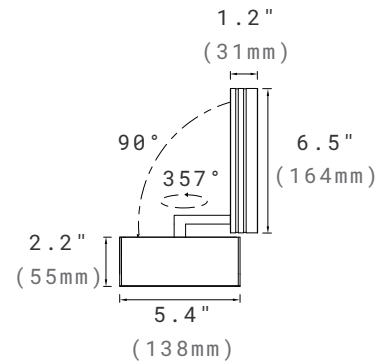
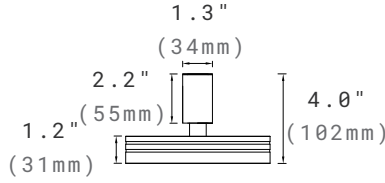
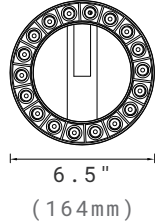

18W with Diffused Lens

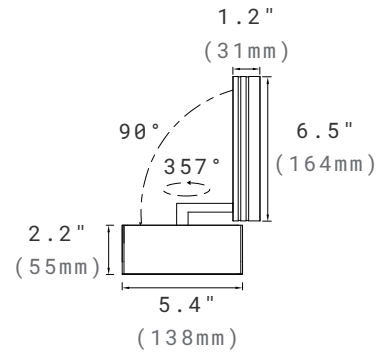
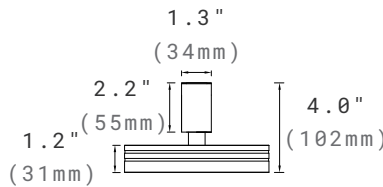
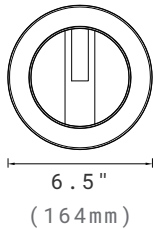

PERFORMANCE DATA

Lumen values are measured by third party certified laboratories performed in accordance with IESNA LM-79-08 as well as Lighting Facts listed.

Wattage	Lens	Lumen Output	CRI	CCT	LPW
12W	20°/34°/48°	1150lm	90	3000K	95
12W	Diffused	650lm	90	3000K	54
18W	20°/34°/48°	1750lm	90	3000K	97
18W	Diffused	950lm	90	3000K	53

STRAIGHT MAGNETIC TRACK LIGHT

Meteor Pendant



Not only for decoration, it's professional in atmosphere creation by precious light control. Thanks to the length adjustable cable, the magnetic pendant works smooth in different spaces. Comfortable lighting without glare.

TECHNICAL DATA

Wattage	5W
Input Voltage	24VDC
Lens	Diffused
CCT	2700K, 3000K, 3500K, 4000K
CRI	90Ra
Driver	Triac, 0/1-10V
Certifications	cETL Listed RoHS compliant
Installation	Magnetic
Environment	Indoor



4"



8"

ORDERING INFORMATION

EXAMPLE: MET8-05-3090-24V-DL-MTM-BK

MET Series	Tube Length	Wattage	CCT&CRI	Voltage	Lens	Installation	Finish
MET	4 4"	05 5W	2790 2700K/90Ra	24V ¹ 24VDC ¹	DL Diffused	MTM Magnetic Track Mount	BK ² Black ² WH ² White ²
	8 8"		3090 3000K/90Ra				
			3590 3500K/90Ra				
			4090 4000K/90Ra				

NOTE:

1. The fixture is used for 24V magnetic track system.
2. Black and white finish is standard. Custom finish colors are available at an additional charge. Please contact Customer Service for premium options.

DIMENSION

4" Tube

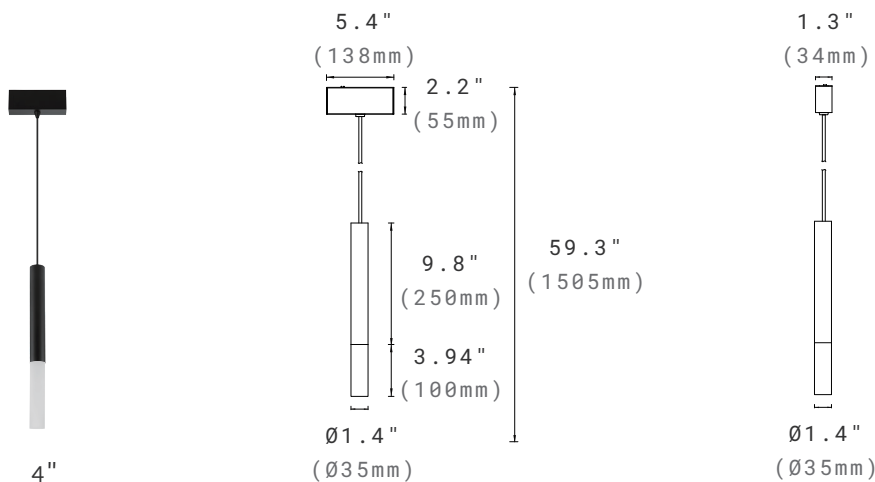

STRAIGHT MAGNETIC TRACK LIGHT

Meteor Pendant

8" Tube

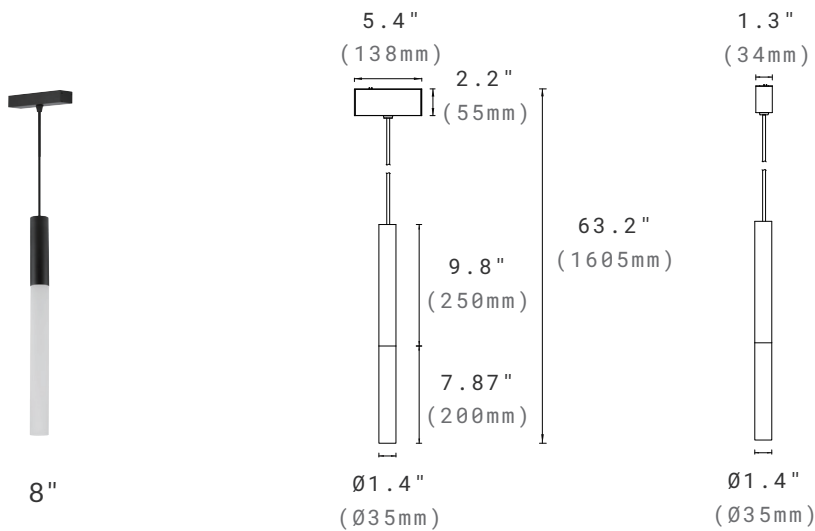

PHOTOMETRY

All published luminaire photometric testing performed to IESNA LM-79-08 standards by a NVLAP certified laboratory. IESNA LM-79-08 specifies the entire luminaire as the source resulting in a fixture efficiency of 100%. Results may vary per actual order.

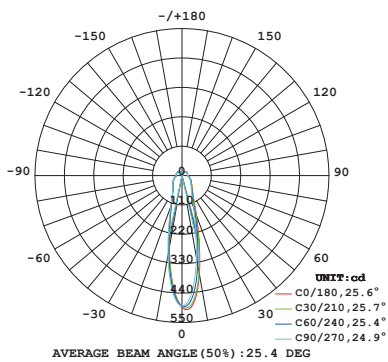

MET4

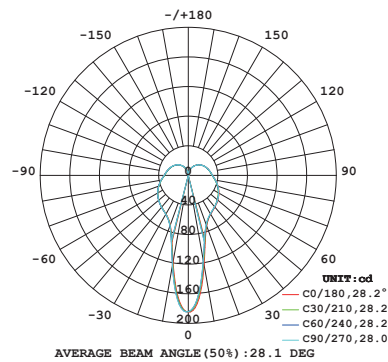

MET8

PERFORMANCE DATA

Lumen values are measured by third party certified laboratories performed in accordance with IESNA LM-79-08 as well as Lighting Facts listed.

Wattage	Tube Length	Lumen Output	CRI	CCT	LPW
5W	3.94"	460lm	90	3000K	92
5W	7.87"	460lm	90	3000K	92



Our Jasper Magnetic Track Light is designed for decorative and general lighting. Different inner and outer finish color. Semi spherical shape yields a smooth uniform light output. The fixture is available as pendant mounted to our 24V magnetic track system.

TECHNICAL DATA

Wattage	10W
Input Voltage	24VDC
Beam Angel	80°
CCT	2700K, 3000K, 3500K, 4000K
CRI	90Ra
Driver	Triac, 0/1-10V
Certifications	cETL Listed RoHS compliant
Installation	Magnetic
Environment	Indoor



White Inner Shade
Black Outer Shade



White Inner Shade
White Outer Shade



Magnetic Track Profile



Magnetic Track Profile
Recessed with Flange

NOTE:

Straight Magnetic Track Profile sold separately.

ORDERING INFORMATION

EXAMPLE: JAS10-3090-24V-80-MTM-GDBK

JAS Series	Wattage	CCT&CRI	Voltage	Beam Angle	Installation	Inner and Outer Shade Color
JAS	10 10W	2790 2700K/90Ra 3090 3000K/90Ra 3590 3500K/90Ra 4090 4000K/90Ra	24V ¹ 24VDC ¹	80 80 degree	MTM Magnetic Track Mount	GDBK ² Golden Inner Shade and Black Outer Shade ² WHBK ² White Inner Shade and Black Outer Shade ² WHWH ² White Inner Shade and White Outer Shade ²

NOTE:

1. The fixture is used for 24V magnetic track system.
2. Golden inner shade and black outer shade is the standard finish. Custom finish colors are available at an additional charge. Please contact Customer Service for premium options.

DIMENSION

10W

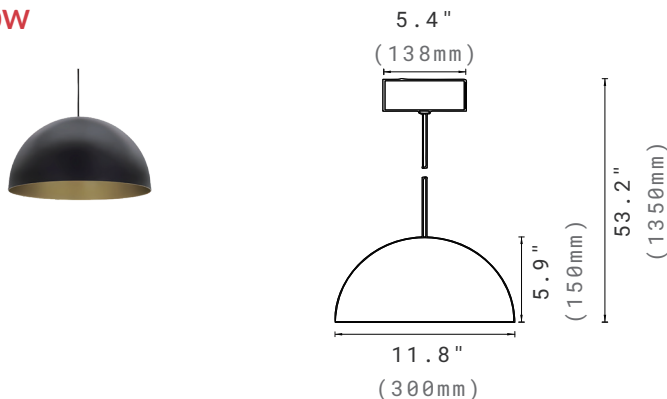

PHOTOMETRY

All published luminaire photometric testing performed to IESNA LM-79-08 standards by a NVLAP certified laboratory. IESNA LM-79-08 specifies the entire luminaire as the source resulting in a fixture efficiency of 100%. Results may vary per actual order.

Luminous Intensity Distribution Diagram

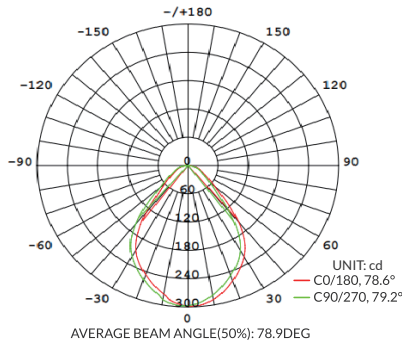

PERFORMANCE DATA

Lumen values are measured by third party certified laboratories performed in accordance with IESNA LM-79-08 as well as Lighting Facts listed.

Wattage	Shade Color	Lumen Output	CRI	CCT
10W	Golden Inner Shade Black Outer Shade	460lm	90	3000K
10W	White Inner Shade Black Outer Shade	500lm	90	3000K
10W	White Inner Shade White Outer Shade	500lm	90	3000K

STRAIGHT MAGNETIC TRACK LIGHT

Bell Pendant



The Bell Pendant is for decoration and general lighting. Elegant body coating. 65° beam angle. Comfortable lighting without glare. Thanks to the length adjustable cable, the magnetic pendant works smooth in different spaces.

TECHNICAL DATA

Wattage	10W
Input Voltage	24VDC
Beam Angle	65°
CCT	2700K, 3000K, 3500K, 4000K
CRI	90Ra
Driver	Triac, 0/1-10V
Certifications	cETL Listed RoHS compliant
Installation	Magnetic
Environment	Indoor



Magnetic Track Profile



Magnetic Track Profile
Recessed with Flange

NOTE:

Straight Magnetic Track Profile sold separately.

ORDERING INFORMATION

EXAMPLE: BEL10-3090-24V-65-MTM-BK

BEL						
Series	Wattage	CCT&CRI	Voltage	Beam Angle	Installation	Finish
BEL	10 10W	2790 2700K/90Ra 3090 3000K/90Ra 3590 3500K/90Ra 4090 4000K/90Ra	24V ¹ 24VDC ¹	65 65 degree	MTM Magnetic Track Mount	BK ² Black ² WH ² White ²

NOTE:

1. The fixture is used for 24V magnetic track system.
2. Black and white finish is standard. Custom finish colors are available at an additional charge. Please contact Customer Service for premium options.

DIMENSION

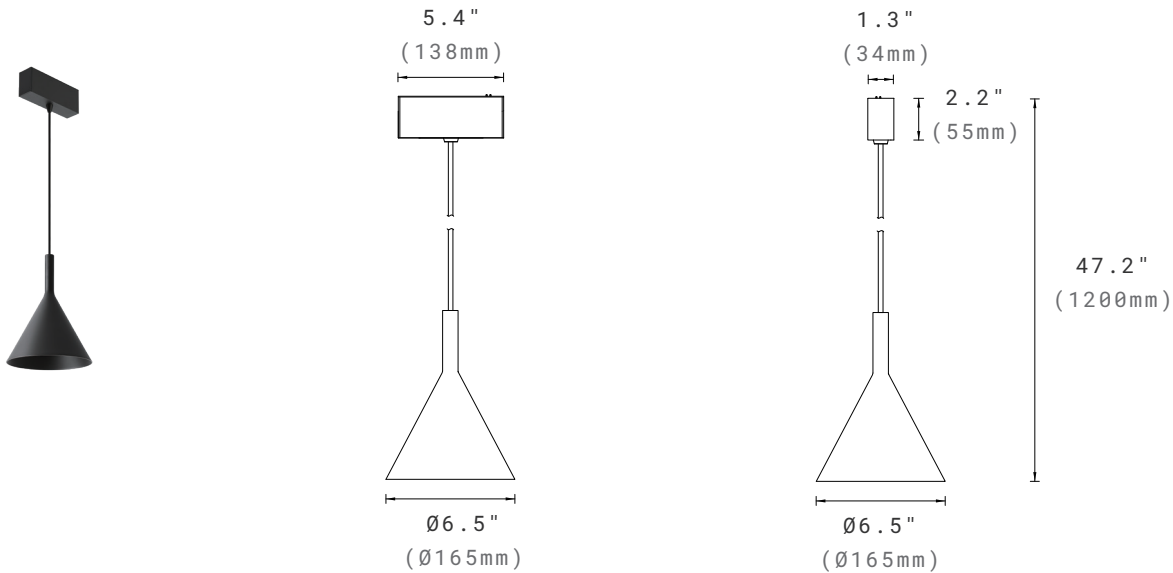

PHOTOMETRY

All published luminaire photometric testing performed to IESNA LM-79-08 standards by a NVLAP certified laboratory. IESNA LM-79-08 specifies the entire luminaire as the source resulting in a fixture efficiency of 100%. Results may vary per actual order.

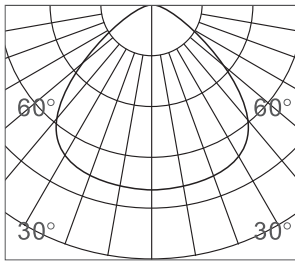

h(m)	E(lx)	Φ(m)
1	500	Φ1.20
2	125	Φ2.40
3	55.6	Φ3.60
4	31.2	Φ4.80
5	20	Φ6.00

PERFORMANCE DATA

Lumen values are measured by third party certified laboratories performed in accordance with IESNA LM-79-08 as well as Lighting Facts listed.

Wattage	Beam Angle	Lumen Output	CRI	CCT	LPW
10W	65°	480lm	90	3000K	48

WARRANTY

5 years limited warranty.

Specifications subject to change without notice.