

# 5" CORLA DOWNLIGHT

## Commercial Series

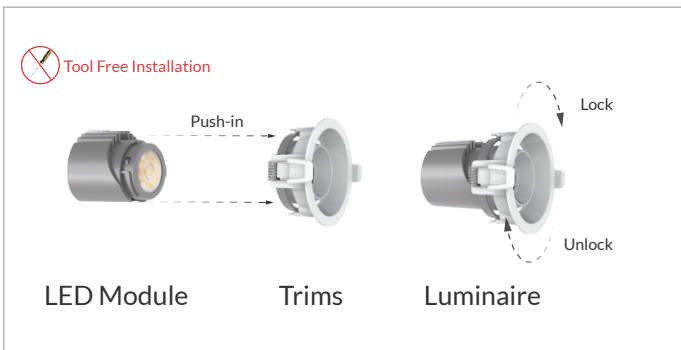

The Corla Downlight System revolutionizes interior lighting through modular adaptability. Featuring precision-engineered optics and adjustable configurations, the system delivers exceptional light quality with superior optical control.

### TECHNICAL DATA

<b>Wattage</b>	30W, 35W (single module)
<b>CRI</b>	90, SDCM<3
<b>CCT</b>	2700K, 3000K, 3500K, 4000K Dim to Warm: 2000K-3000K
<b>Dimming</b>	Triac dimming (1%-100%) 0-10V dimming (3%-100%)
<b>Input Voltage</b>	120-277V, 50/60Hz
<b>Projected Lifetime</b>	L80-50,000 hours
<b>Working Temperature</b>	-4°F to 104°F (-20°C to 40°C)
<b>Certifications</b>	ETL Listed to US and Canadian standards Suitable for damp locations RoHS compliant
<b>Power Factor</b>	>0.9 at full load
<b>Harmonic Distortion</b>	<20% at full load

### FEATURES

- **Super Modular Design:** 2 mounting trims and tool-free interchangeable components.
- **Precise Light Control:** 4 beam angles (15°/24°/38°/55°), anti-glare accessories, and a 38° cutoff angle. 355° rotation & 30° tiltable.
- **Versatile Project Adaptability:** supports general lighting, spot/flood and accent lighting.
- **Optimized Thermal Performance:** guarantees long-term durability and consistent luminous performance.

## SPECIFICATION

### LED Module



4-1/4"  
(108mm)

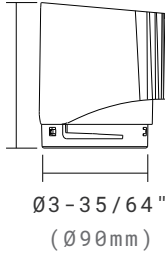

### Trims



5-1/2"  
(140mm)

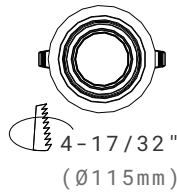
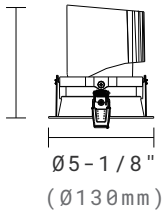

### Round Adjustable



5-1/2"  
(140mm)

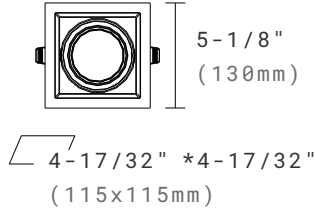
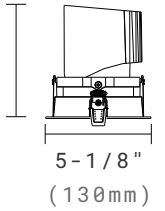

### Square Adjustable

### Remodel Mounted Driver

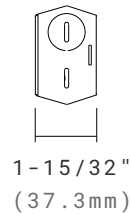
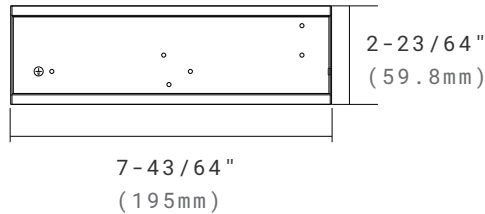

## ORDERING INFORMATION

**EXAMPLE** COR 05 30 35 90 1 XD 38

1            2            3            4            5            6            7            8

### 1. Series

- COR-** Corla LED Module

### 2. Size

- 05** - 5 inch Module

### 3. Wattage (single module)

- 30** - 30W       **35** - 35W

### 4. CCT

- 27** - 2700K       **30** - 3000K  
 **35** - 3500K       **40** - 4000K  
 **DTW**- 2000K-3000K dim to warm

### 5. CRI

- 90** - 90Ra

### 6. Voltage

- 1** - 120-277V

### 7. Dimming

- XD** - 0-10V/Triac Dimming

#### NOTE:

1. Triac dimming only works on 120VAC.

### 8. Beaming Angle

- 15** - 15°       **24** - 24°  
 **38** - 38°       **55** - 55°



### Mounting Accessory Options

- RIP-55135**  
 **RIP-70145**  
 New construction pre-mounting plate for Corla Downlight.

#### NOTE:

1. Please refer to the Selection Guide to select proper plate.



### Trim Options

- CORC05-R-ADJ-WH**  
 Commercial series, round trim, adjustable, white trim 
- CORC05-S-ADJ-WH**  
 Commercial series, square trim, adjustable, white trim 

#### NOTE:

1. White trim is standard finish. Custom colors are available at an additional fee.

### Optical Accessory Options

- COR05-HCB**   
 Honeycomb Filter
- COR05-BSL**   
 Beam Soft Lens

### Emergency Battery Back-up Options

- AAL-EBU-AC08D-YYY**  
 Remote 8W LED Emergency Battery Back-up 120-347VAC
- AAL-EBU-AC15D-YYY**  
 Remote 15W LED Emergency Battery Back-up 120-347VAC
- AAL-EBU-AC25D-YYY**  
 Remote 25W LED Emergency Battery Back-up 120-347VAC



#### NOTE:

1. A single EBU can power multiple light fixtures. The 8W EBU supports up to 60W total lighting load, 15W EBU supports up to 100W total lighting load, while the 25W EBU supports up to 150W total lighting load.
2. The dimming control wire is optional when the combined power of all connected lights is lower than the EBU's rated power.
3. The dimming control wire must be connected when the total power of all connected lights exceeds the EBU's rated capacity.

## ROUGH-IN PLATE SELECTION GUIDE

To ensure a proper fit, select the correct rough-in plate by matching it to your fixture's cutout size.

Follow the 2 steps below:

**Step 1.** Identify the Cutout Size: Locate the Corla Downlight model in the table below and note its required cutout dimension.

**Step 2.** Match the Plate: Using the diagram that follows, find the rough-in plate part# that corresponds to the cutout size you identified in Step 1.

**Corla Downlight Cutout Dimension Table**

Model	Hotel	Residential	Commercial	Deep Anti-Glare	Wall Washer
COR02	Ø2.17"(55mm)	Ø2.17"(55mm)	Ø2.56"(65mm)	/	/
COR03	Ø2.95"(75mm)	Ø2.95"(75mm), Ø2.68"(68mm)	Ø3.15"(80mm)	Ø2.95"(75mm)	Ø2.95"(75mm)
COR04	Ø3.94"(100mm)	Ø4.53"(115mm), Ø3.94"(100mm)	Ø3.74"(95mm)	Ø3.94"(100mm)	/
COR05	Ø4.92"(125mm), Ø4.8"(122mm)	Ø4.33"(110mm), Ø4.92"(125mm) Ø5.12"(130mm), Ø5.31"(135mm)	Ø4.53"(115mm)	Ø4.92"(125mm)	/

### Rough-in Plate

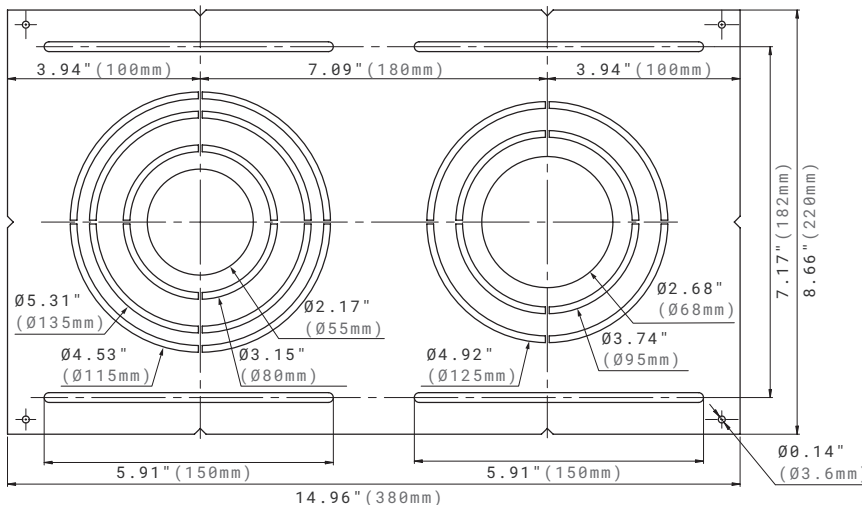

Part#

**RIP-55135**

New construction pre-mounting plate for Corla Downlight.

Compatible cutouts:

- Ø2.17"(Ø55mm)
- Ø2.68"(Ø68mm)
- Ø3.15"(Ø80mm)
- Ø3.74"(Ø95mm)
- Ø4.53"(Ø115mm)
- Ø4.92"(Ø125mm)
- Ø5.31"(Ø135mm)

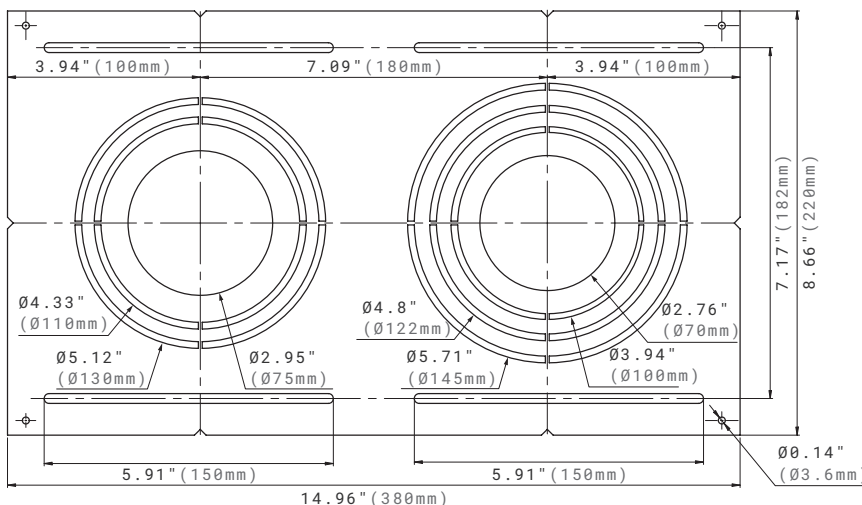

Part#

**RIP-70145**

New construction pre-mounting plate for Corla Downlight.

Compatible cutouts:

- Ø2.76"(Ø70mm)
- Ø2.95"(Ø75mm)
- Ø3.94"(Ø100mm)
- Ø4.33"(Ø110mm)
- Ø4.8"(Ø122mm)
- Ø5.12"(Ø130mm)
- Ø5.71"(Ø145mm)

### PHOTOMETRY

All published luminaire photometric testing performed to IESNA LM-79-08 standards by a NVLAP certified laboratory. IESNA LM-79-08 specifies the entire luminaire as the source resulting in a fixture efficiency of 100%. Results may vary per actual order.

#### 30W

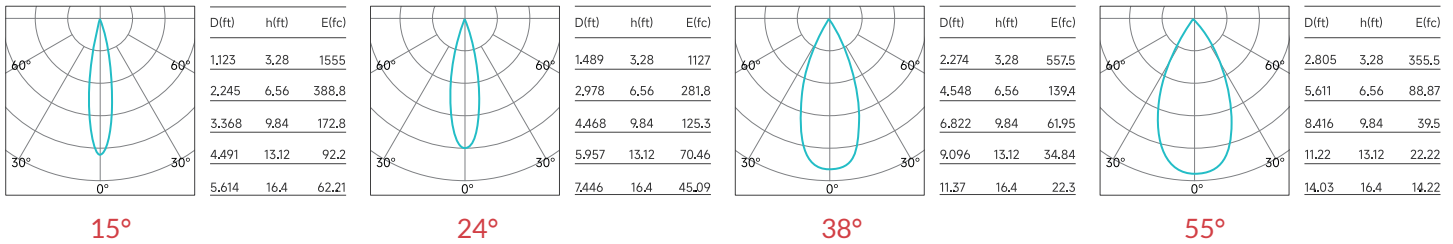

#### 35W

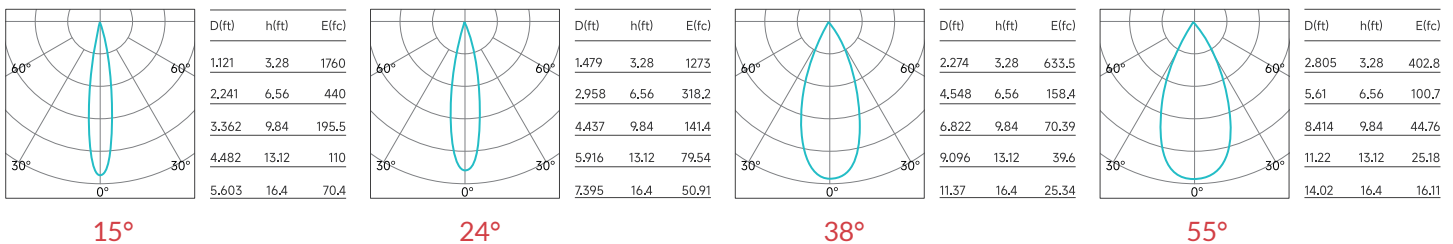

Above test data is based on **Round Adjustable** trim with 3000K 90CRI LED.

### PERFORMANCE DATA

POWER	CCT	CRI	BEAM OPTIC	LUMENS (lm)	EFFICACY (lm/W)	MAX CANDELA (cd)
30W	3000K	90	15°	2632	95	16717
			24°	2683	97	12136
			38°	2667	96	6084
			55°	2601	94	3861
35W	3000K	90	15°	2980	93	18874
			24°	3040	95	13729
			38°	3020	94	6886
			55°	2940	92	4369

Above test data is based on **Round Adjustable** trim with 3000K 90CRI LED.

### LUMEN MULTIPLIERS

CCT	MULTIPLIER
2700K	0.95
3000K	1.00
3500K	1.04
4000K	1.06