



## Modular design for endless possibilities

These models blend timeless aesthetics and high-performance COB LED to create pleasant, uniformly illuminated indoor environments.



The Melo Cylinder would greatly create possibilities in the whole commercial area. Multiple sizes, beam options, and high visual comfort COB LED. It is now available in pendant surface and wall mount configurations which offers a beautiful and architectural cylinder solutions.

## TECHNICAL DATA

### Wattage

4 inch	25W/18W/12W
6 inch	40W/30W/20W
8 inch	58W/44W/29W

**Beam Angle** 15°, 24°, 36°, 60°, 70°(for drop lens)

### CRI

Standard	80
Optional	90+

**CCT** 2700K, 3000K, 3500K, 4000K

### Driver

Standard	0-10V Dimming, dim to 10%
Optional	0-10V Dimming, dim to 1%
Optional	TRIAC Dimming

**Input Voltage** 120-277V, 50/60Hz

**Operating Temp.** -4°F to 77°F(-20°C to 25°C)

**Certifications** cULus conforms to UL Std. 1598  
Cert. to CSA Std. C22.2 No.250.0  
Suitable for damp locations  
RoHS compliant

**Power Factor** >0.9 at full load

**Harmonic Distortion** <20% at full load

**Projected Lifetime** L70 - 100,000 Hours

## FEATURES

- **Optical Performance:** COB LED chip with a standard CRI of 80+ and an optional high CRI of 90+, offering a selection of beam angles including 15°, 24°, 36°, 60° and 70°(for drop lens) .
- **Mounting Options:** Modular design with pendant, surface and wall mount.

## CANOPY OPTIONS

### Flat Canopy For Recessed J-box

If J-box is recessed (3" octagon, 4" octagon and 4" round ), a 4.5" flat canopy is provided for mounting to recessed junction box in white or black powder coat painted finish.

### Conduit Deep Canopy For Conduit surface J-box

If standard 4" octagonal J-box is surface mounted, a Ø5.97" round x 2.38" deep canopy with conduit cutout is provided for mounting. Conduit cutout canopy has 4 key slots, one in each side, and can be configured to accommodate any ceiling layout using 1/2" or 3/8" conduit. Conduit cutout canopy is provided white and black powder coat painted finish.

### Conduit Mounting Example

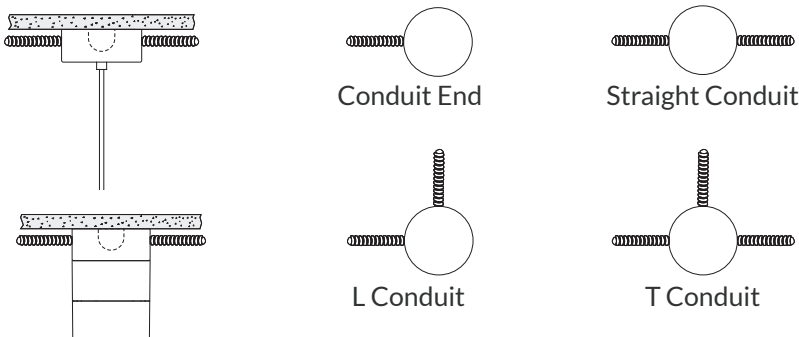

## MOUNTING

### Cable Pendant Mount

White/black cable is provided in length specified ( 4' standard ). Installers can cut the cable in the field to desired length.

#### Notes:

1. For 4", the cable and aircraft cable is combined in one pipe.
2. For 6" and 8", the cable and aircraft cable are separated.

### Stem Pendant Mount

Ø12/25" steel stem is provided in length specified ( 4' standard) and is provided in white or black finish.

Swivel design suitable for a sloped ceiling.

### Surface Mount







Surface mount to recessed or surface conduit junction box.

### Wall Mount



Wall mount to recessed junction box.

## MOUNTING

### Pendant Mount

For Recessed J-box				For Conduit Surface J-box			
							
Cable Pendant 4"	Cable Pendant 6" / 8"	Stem Pendant Tilt up to 30° 4" / 6" / 8"		Cable Pendant 4"	Cable Pendant 6" / 8"	Stem Pendant Tilt up to 30° 4" / 6" / 8"	

### Surface Mount

For Recessed J-box	For Conduit Surface J-box		
			
Surface Mount 4" / 6" / 8"	Surface Mount 4"	Surface Mount 6"	Surface Mount 8"

### Wall Mount

		
Wall Mount 4"	Wall Mount 6"	Wall Mount 8"

## DIMENSIONS

4"

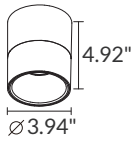

4" drop lens

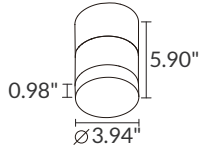

6"

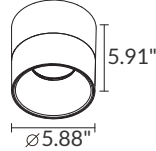

8"

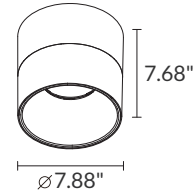

### For recessed J-boxes

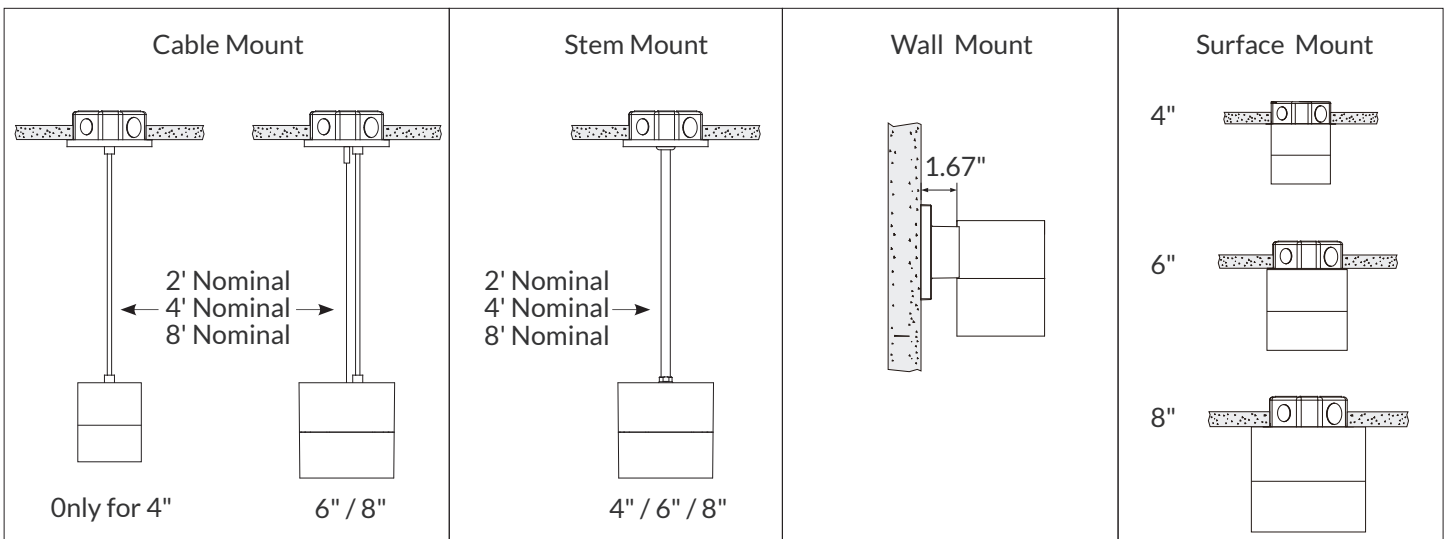



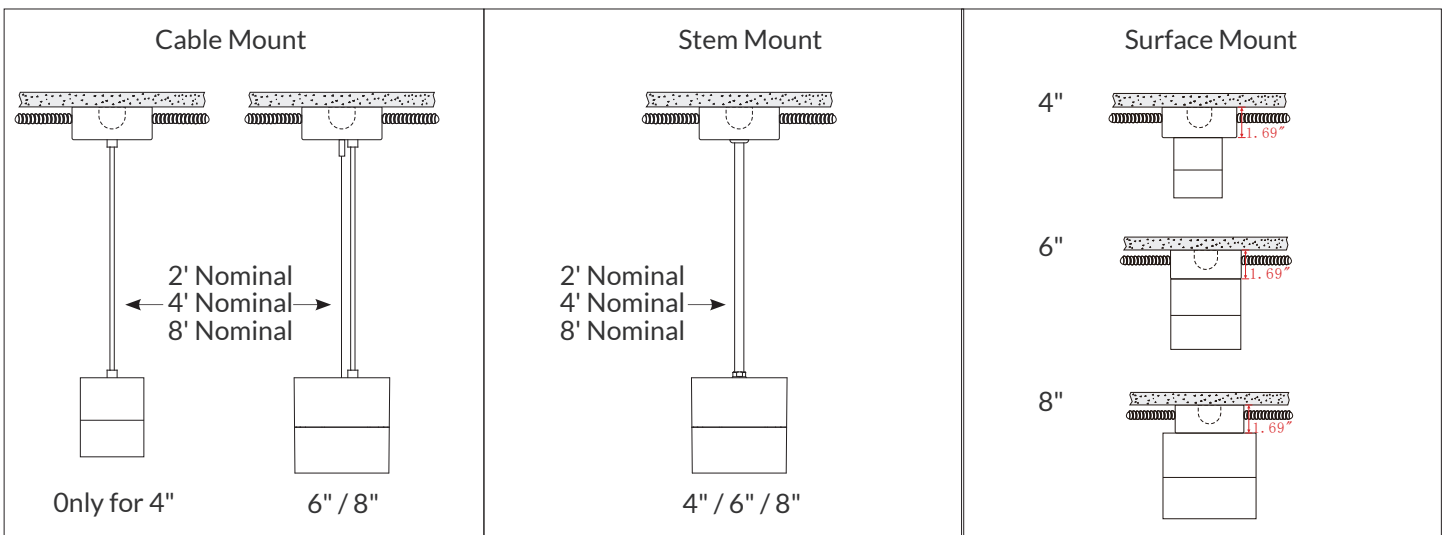

### For conduit surface J-boxes



## ORDERING INFORMATION

EXAMPLE: MELO04R-SP30901-10D-36-WH-WH

MELO					
1. Series	2. Size	3. Shape	4. Power	5. CCT	6. CRI
MELO	<b>04</b> 4 inch  <b>06</b> 6 inch  <b>08</b> 8 inch	<b>R</b> Round	<b>SP</b> Wattage Selectable 25W/18W/12W for 4inch 40W/30W/20W for 6inch 58W/44W/29W for 8inch  <i>*Static wattages available.</i>	<b>27</b> 2700K  <b>30</b> 3000K  <b>35</b> 3500K  <b>40</b> 4000K	<b>80</b> 80+ CRI (Standard)  <b>90</b> 90+ CRI (Optional)
7. Voltage	8. Dimming	9. Installation	10. Beam Angle	11. Baffle	12. Finish
<b>1</b> 120-277V	<b>10D</b> Standard 0-10V Dimming, dim to 10%  <b>01D</b> Optional 0-10V Dimming, dim to 1% or Triac Dimming  <i>*Triac dimming only works at 120V.</i>	<b>Blank</b> Surface mount for recessed J-box  <b>ACPMK</b> Aircraft Cable Pendant Mount Kits  <b>RPMK</b> Rod Pendant Mount Kits  <b>WM</b> Wall Mount  <i>*Aircraft &amp; rod pendant mount and conduit surface mount need to order separate mount kits. Please refer to the following accessory table for details.</i>	<b>15</b> 15°  <b>24</b> 24°  <b>36</b> 36°  <b>60</b> 60°  <b>70</b> 70° Drop Lens  <i>*Drop lens is only available for 4 inch.</i>	<b>WH</b> White   <b>BK</b> Black   <b>GD</b> Golden   <b>CM</b> Chrome   <b>DL</b> Drop Lens  1 inch thickness	<b>WH</b> White  <b>BK</b> Black  <i>*White or black finish is standard. Custom color is available for a premium setup fee. Consult customer service for additional information.</i>

## ACCESSORIES (ORDERED SEPARATELY AND FIELD INSTALLED)

### For Recessed Junction Box

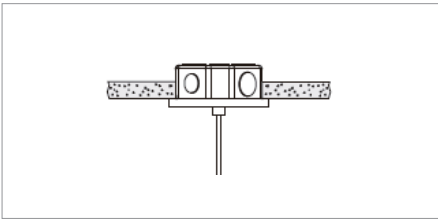

#### MELO-PMK-AC-RM-4-4FT-WH

Aircraft cable mount for 4" MELO, 4ft long cable, white (recessed junction box).

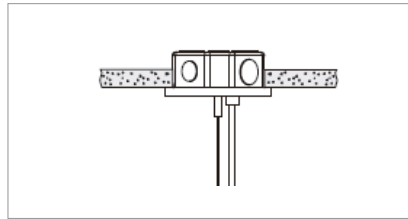

#### MELO-PMK-AC-RM-6/8-4FT-WH

Aircraft cable mount for 6" and 8" MELO, 4ft long cable, white (recessed junction box).

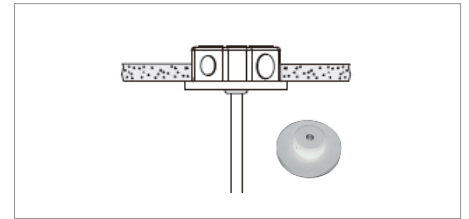

#### MELO-PMK-RS-RM-4/6/8-4FT-WH

Rigid stem mount for 4"/6"/8" MELO, 4ft long stem, white (recessed junction box).

Note:

4ft long is standard. 2ft/8ft/12ft are available. Please contact Customer Service.

### For Conduit Surface Junction Box

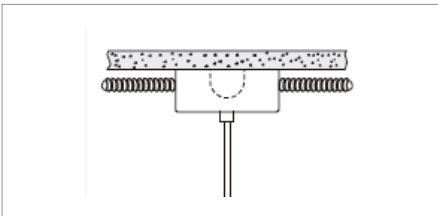

#### MELO-PMK-AC-SM-4-4FT-WH

Aircraft cable mount for 4" MELO, 4ft long cable, white (conduit surface junction box).

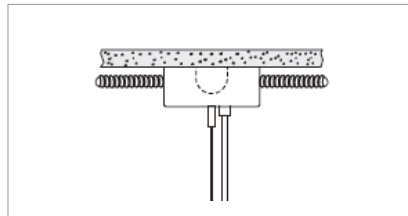

#### MELO-PMK-AC-SM-6/8-4FT-WH

Aircraft cable mount for 6" and 8" MELO, 4ft long cable, white (conduit surface junction box).

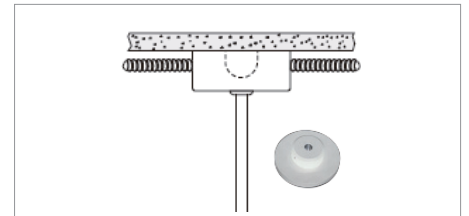

#### MELO-PMK-RS-SM-4/6/8-4FT-WH

Rigid stem mount for 4"/6"/8" MELO, 4ft long stem, white (conduit surface junction box).

Note:

4ft long is standard. 2ft/8ft/12ft are available. Please contact Customer Service.



#### MELO-SMK-SM-SM-4/6/8-WH

Conduit surface mount kits for 4"/6"/8" MELO, white (conduit surface junction box).

## ACCESSORIES (ORDERED SEPARATELY AND FIELD INSTALLED)



### AAL-EBU-AC08D-YYY

Remote 8W LED Emergency Battery Back-up 120-347VAC

### AAL-EBU-AC15D-YYY

Remote 15W LED Emergency Battery Back-up 120-347VAC

### AAL-EBU-AC25D-YYY

Remote 25W LED Emergency Battery Back-up 120-347VAC

### NOTE:

1. The 8W EBU supports up to 60W total lighting load, 15W EBU supports up to 100W total lighting load, while the 25W EBU supports up to 150W total lighting load.
2. The dimming control wire is optional when the combined power of all connected lights is lower than the EBU's rated power.
3. The dimming control wire must be connected when the total power of all connected lights exceeds the EBU's rated capacity.

## FREE COMBINATIONS



## PHOTOMETRY

All published luminaire photometric testing performed to IESNA LM-79-08 standards by a NVLAP certified laboratory. IESNA LM-79-08 specifies the entire luminaire as the source resulting in a fixture efficiency of 100%. Results may vary per actual order.

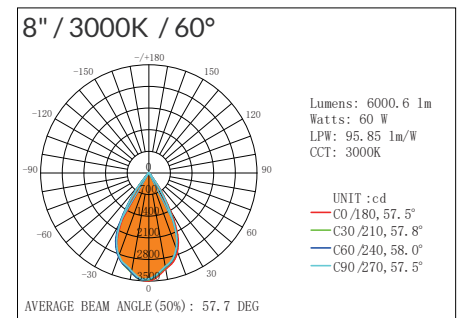
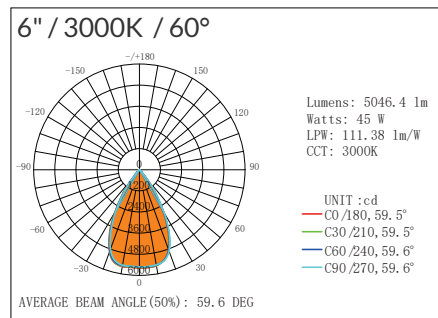
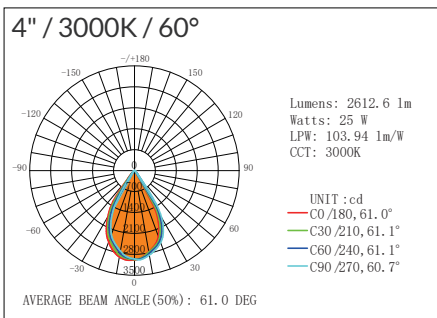

## PERFORMANCE DATA

Lumen values are measured by third party certified laboratories performed in accordance with IESNA LM-79-08 as well as Lighting Facts listed.

Wattage	2700K		3000K		3500K		4000K	
	Ra>80	Ra>90	Ra>80	Ra>90	Ra>80	Ra>90	Ra>80	Ra>90
25W/18W/12W selectable	2250lm 90lm/w	1900lm 76lm/w	2375lm 95lm/w	2000lm 80lm/w	2450lm 98lm/w	2050lm 82lm/w	2500lm 100lm/w	2100lm 84lm/w
40W/30W/20W selectable	4000lm 100lm/w	3400lm 85lm/w	4200lm 105lm/w	3560lm 89lm/w	4320lm 108lm/w	3640lm 91lm/w	4400lm 110lm/w	3720lm 93lm/w
58W/45W/30W selectable	4930lm 85lm/w	4176lm 72lm/w	5220lm 90lm/w	4408lm 76lm/w	5394lm 93lm/w	4524lm 78lm/w	5510lm 95lm/w	4640lm 80lm/w

\*The above lumen outputs apply to highest wattage with white trim and 60° beam angle.

Correlated Trim Color Multiplier	White Trim	Black Trim	Gold Trim	Chrome Trim
Multiplier for Lumen Output	1	0.92	0.97	0.94

## DIMMER COMPATIBLE

0-10V Dimming (Dim to 10%)

LEVITON DD710	LUTRON MS-Z101	LUTRON NTSTV-DV	LEGRAND RH4FBL3PTC	LUTRON DVSTV	LEVITON IP710
✓	✓	✓	✓	✓	✓

0-10V Dimming (Dim to 1%)

LEVITON DD710	LUTRON MS-Z101	LUTRON NTSTV-DV	LEGRAND RH4FBL3PTC	LUTRON DVSTV	LEVITON IP710
✗	4% below	✓	✓	✓	✓

TRIAC Dimming

DV600P	DVCL-153P	6683	DV603P	6672	S-600P	MSCL-DP153M	S-603P
✓	✓	✓	✓	✗	✓	✓	✓

LG-600P	TGCL-153DH	SCL-153P	6674-LEVITON	CTCL-153P	CT-603PG
✓	✓	✓	✓	✓	✓