



The NOVA LED Commercial Downlights are available in 4inch, 6inch, 8inch and 10inch with up to 60W. The integral junction box and choice of trim feature, adds to the flexibility of this downlight. Butterfly clips make for easy-fit installation whether new construction or retrofit. The integral junction box eliminates the need for a traditional recessed housing and the complete fixture mounts directly into the ceiling. It is suitable for commercial and public places and elegantly decorates the ambience, such as shopping mall, hospital, airport, hotel lobby etc.

TECHNICAL DATA

Wattage

20SP	Selectable 10W/15W/20W
40SP	Selectable 27W/34W/40W
60SP	Selectable 40W/50W/60W
CCT	Selectable 3000K/3500K/4000K default setting: 4000K

Driver	1-10V dimming is standard
CRI	80

Input Voltage

20SP/40SP	120-347V, 50/60Hz (dim to 10%)
60SP	120-277V, 50/60Hz (dim to 1%)

Projected Lifetime	L70-100,000 Hours
--------------------	-------------------

Operating Temp.	-4°F to 104°F (-20°C to 40°C)
-----------------	-------------------------------

Certifications	cULus conforms to UL Std. 1598 Cert. to CSA Std. C22.2 No.250.0 RoHS compliant Suitable for damp locations
----------------	---

Power Factor	>0.9 at full load
--------------	-------------------

Harmonic Distortion	<20% at full load
---------------------	-------------------

FEATURES

- 4inch, 6inch, 8inch and 10inch trim size options.
- Various changable trim design.
- Available in round, square, round wall wash and square wall wash trims.
- Twist-lock modular design.
- Integrated J-box for direct wire, eliminated recessed can.
- CCT and wattage selectable.
- New construction frame kit available.

DIMENSION

Engine

20SP

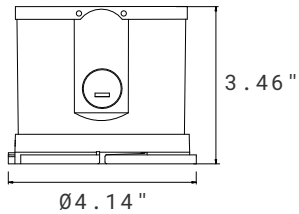

10W IC, 15W IC, 20W IC

40SP

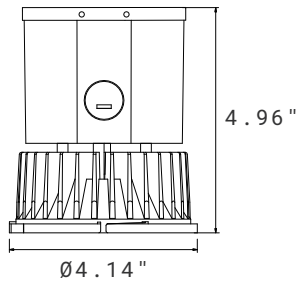

40W NON-IC

60SP

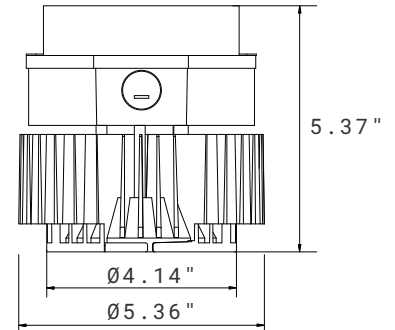

60W NON-IC

Fixture

20SP – Round Trim

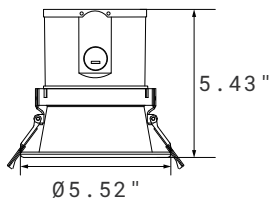

4" Round Trim

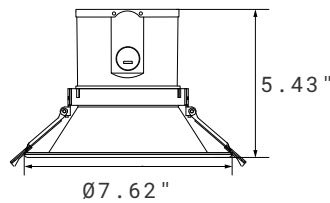

6" Round Trim

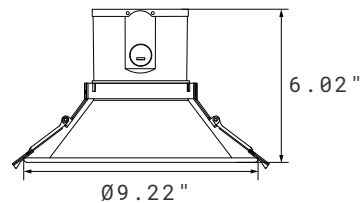

8" Round Trim

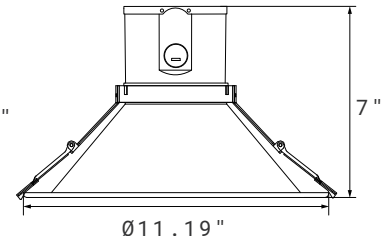

10" Round Trim

20SP – Round Wall Wash Trim

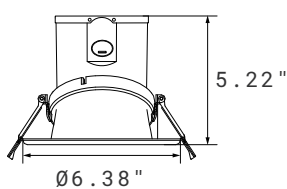

4" Round
Wall Wash Trim

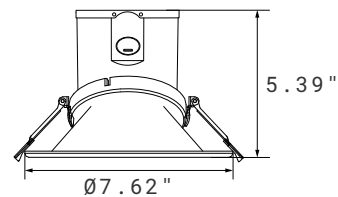

6" Round
Wall Wash Trim

20SP – Square Wall Wash Trim

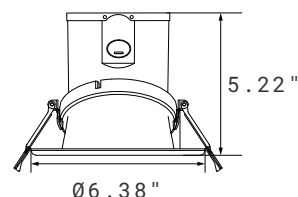

4" Square
Wall Wash Trim

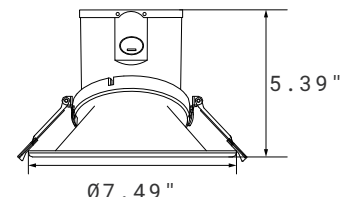

6" Square
Wall Wash Trim

20SP – Square Trim

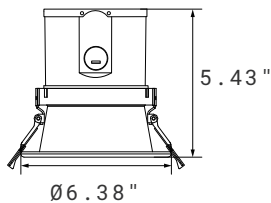

4" Square Trim

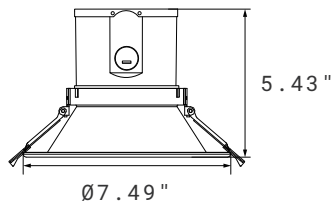

6" Square Trim

DIMENSION

Fixture

40SP – Round Trim

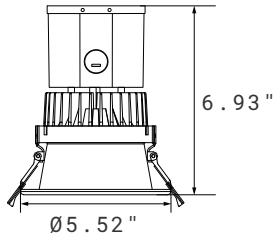

4" Round Trim

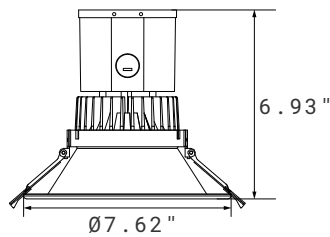

6" Round Trim

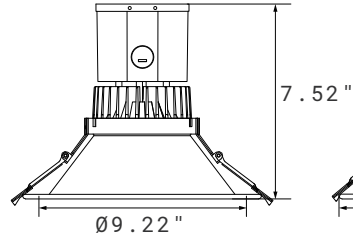

8" Round Trim

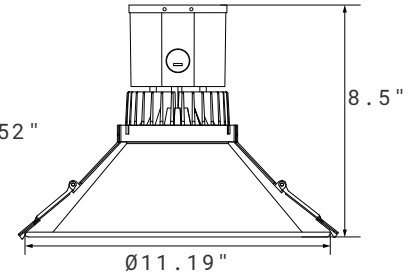

10" Round Trim

40SP – Round Wall Wash Trim

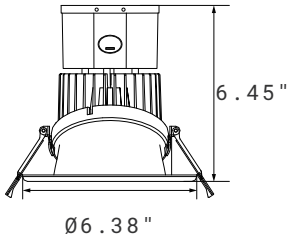

4" Round Wall Wash Trim

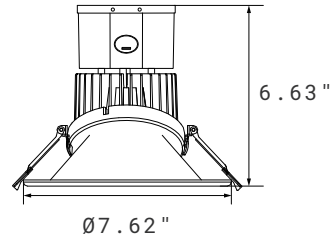

6" Round Wall Wash Trim

40SP – Square Wall Wash Trim

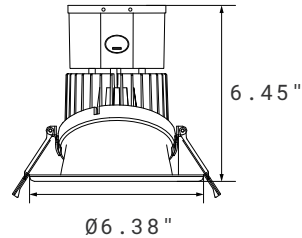

4" Square Wall Wash Trim

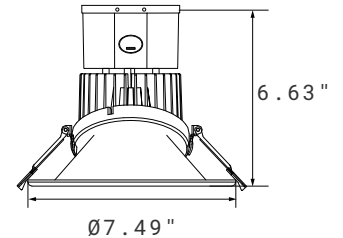

6" Square Wall Wash Trim

40SP – Square Trim

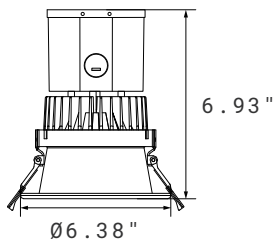

4" Square Trim

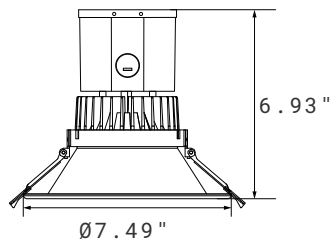

6" Square Trim

60SP – Square Trim

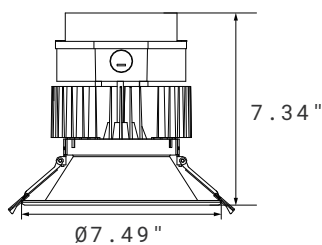

6" Square Trim

60SP – Round Trim

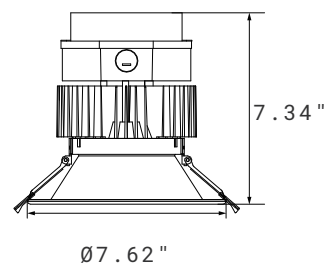

6" Round Trim

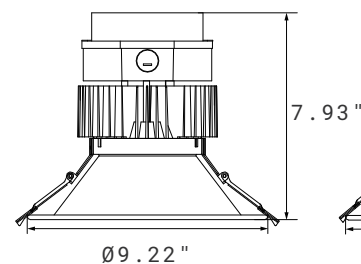

8" Round Trim

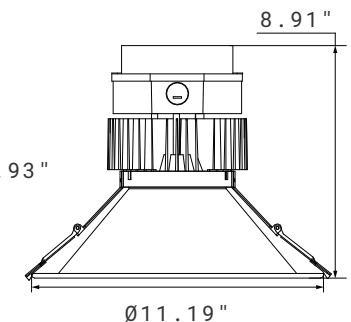

10" Round Trim

DIMENSION

Trim

Round Trims

4"

Cut-hole Dimensions: 4.7"-5.2"



White Ring Metal Trim Rose Trim Black Trim

Metal Reflector



6"

Cut-hole Dimensions: 6"-7.3"



White Ring Metal Trim Rose Trim Black Trim

Metal Reflector

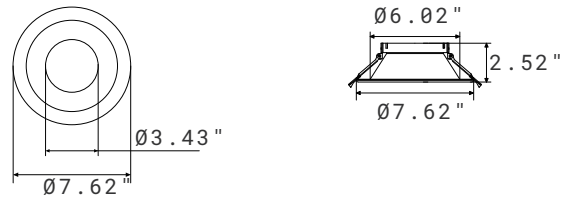

8"

Cut-hole Dimensions: 7.4"-8.9"



White Ring Metal Trim Black Trim

Metal Reflector

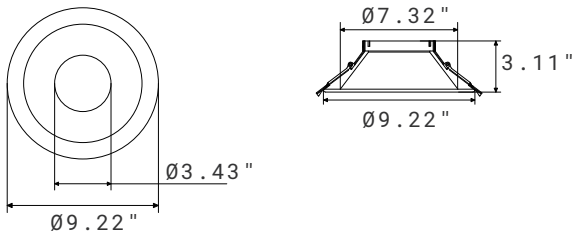

10"

Cut-hole Dimensions: 9.5"-10.8"



White Ring
Metal Reflector

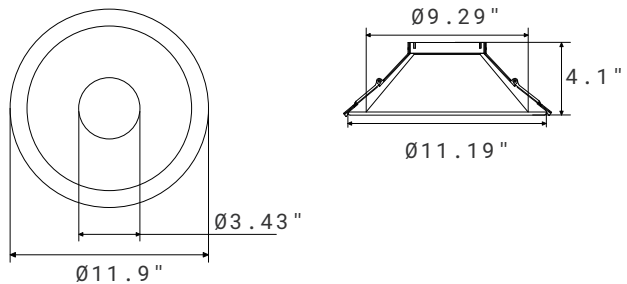

Round Wall Wash Trims

4"

Cut-hole Dimensions: 5.3"-6"

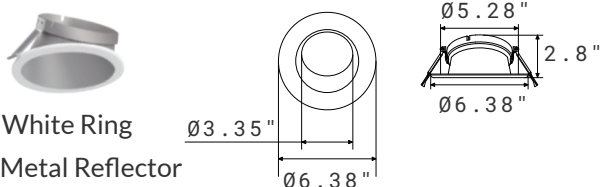

White Ring
Metal Reflector

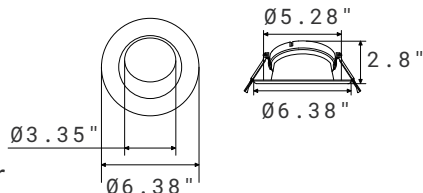

6"

Cut-hole Dimensions: 6"-7.3"

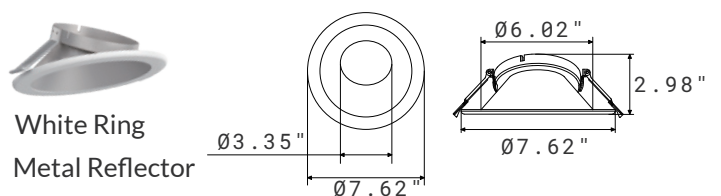

White Ring
Metal Reflector

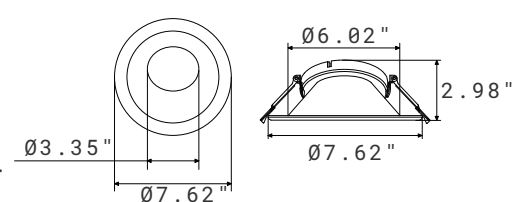

DIMENSION

Trim

Square Trims

4"

Cut-hole Dimensions: 5.3"-6"



White Ring
Metal Reflector

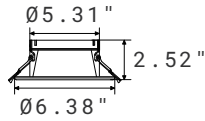
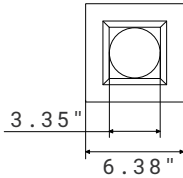

6"

Cut-hole Dimensions: 6"-7.3"

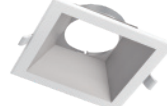

White Ring
Metal Reflector

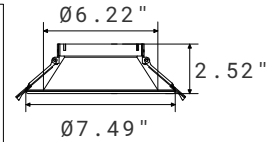
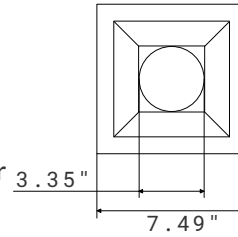

Square Wall Wash Trims

4"

Cut-hole Dimensions: 5.3"-6"

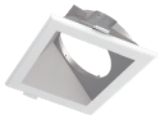

White Ring
Metal Reflector

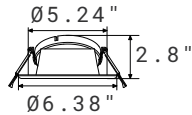
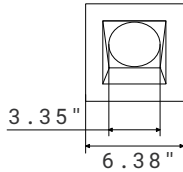

6"

Cut-hole Dimensions: 6"-7.3"



White Ring
Metal Reflector

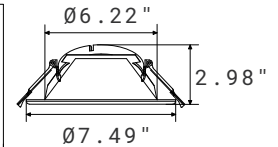
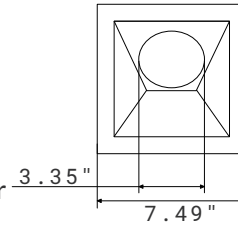

ORDERING INFORMATION

Engine

EXAMPLE: NOVA-20SPSW8

NOVA			
1. Series	2. Wattage	3. CCT	4. Voltage
NOVA 20SP Selectable 10W/15W/20W ¹ 40SP Selectable 27W/34W/40W ¹ 60SP Selectable 40W/50W/60W ¹		SW Selectable 3000K 3500K 4000K ²	<i>For 20SP and 40SP</i> 8 120-347V, dim to 10% <i>For 60SP</i> 1 120-277V, dim to 1% *Tested Dimmers: Lutron® Diva-Dvtv, Leviton® IP-710-DL.

NOTE:

- 20W, 40W and 60W are default setting.
- 4000K is default setting.

TRIM ORDERING GUIDE

Different trims need to be ordered separately and field installed.

Round Trim

EXAMPLE: NOVA4-RT-WH

NOVA			
1. Series	2. Size	3. Shape	4. Finish
NOVA	4 4" Cutout: 4.7"-5.2" *Not available for 60SP. 6 6" Cutout: 6"-7.3" 8 8" Cutout: 7.4"-8.9" 10 10" Cutout: 9.5"-10.8"	RT Round Trim	WH White Ring Reflector is aluminum natural color anodizing treatment. MT Metal Ring Reflector is aluminum natural color anodizing treatment. *Metal color is not available for 10". BK Black ring and reflector *Black is not available for 10". RS Rose ring and reflector *Rose is not available for 8" and 10".

TRIM ORDERING GUIDE

Different trims need to be ordered separately and field installed.

Round Wall Wash Trim

EXAMPLE: NOVA4-RWWT-WH

NOVA 1. Series	2. Size	3. Shape	4. Finish
NOVA	4 4" Cutout: 5.3"-6" 6 6" Cutout: 6"-7.3"	RWWT Round Wall Wash Trim 10°-20° tilt *Not available for 6OSP.	WH White Ring Reflector is aluminum natural color anodizing treatment.

Square Trim

EXAMPLE: NOVA4-ST-WH

NOVA 1. Series	2. Size	3. Shape	4. Finish
NOVA	4 4" Cutout: 5.3"-6" *Not available for 6OSP. 6 6" Cutout: 6"-7.3"	ST Square Trim	WH White Ring Reflector is aluminum natural color anodizing treatment.

Square Wall Wash Trim

EXAMPLE: NOVA4-SWWT-WH

NOVA 1. Series	2. Size	3. Shape	4. Finish
NOVA	4 4" Cutout: 5.3"-6" 6 6" Cutout: 6"-7.3"	SWWT Square Wall Wash Trim 10°-20° tilt *Not available for 6OSP.	WH White Ring Reflector is aluminum natural color anodizing treatment.

ACCESSORIES (ORDERED AND SHIPPED SEPARATELY)

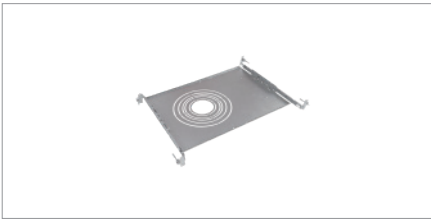

NOVA-3/8-R-RIP
 New Construction.
 Round Pre-mounting Plate.
 Opening for 3" to 8".

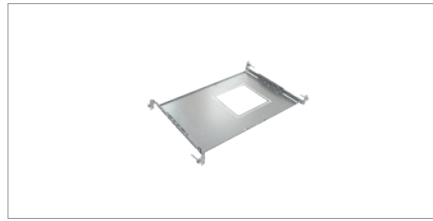

NOVA-4/6-S-RIP
 New Construction.
 Square Pre-mounting Plate.
 Opening for 4" to 6".



AAL-EBU-AC08D-YYY¹
 Remote 8W LED Emergency Battery
 Back-up 120-347VAC.

AAL-EBU-AC25D-YYY¹
 Remote 25W LED Emergency Battery
 Back-up 120-347VAC.

NOTE:

1. The 8W EBU supports up to 60W total lighting load. The 25W EBU supports up to 150W total lighting load. The dimming control wire must be connected. Emergency battery backup operates within ambient temperatures of 32°F to 95°F (0°C to 35°C).

PERFORMANCE DATA

Lumen values are measured by third party certified laboratories performed in accordance with IESNA LM-79-08 as well as Lighting Facts listed.

Wattage	Lumen Output			Type
	High	Medium	Low	
Maximum 20W	20W, 1500lm (75lm/W)	15W, 1170lm (78lm/W)	10W, 800lm/W (80lm/W)	IC
Maximum 40W	40W, 3200lm (80lm/W)	34W, 2890lm (85lm/W)	27W, 2430lm (90lm/W)	NON-IC
Maximum 60W	60W, 6180lm (103lm/W)	50W, 5300lm (106lm/W)	40W, 4360lm (109lm/W)	NON-IC

NOTE:

All efficacy is subject to 4000K which has ±5% base on different CCT and trims. Check the IES file to gain the accurate data.

PHOTOMETRY

All published luminaire photometric testing performed to IESNA LM-79-08 standards by a NVLAP certified laboratory. IESNA LM-79-08 specifies the entire luminaire as the source resulting in a fixture efficiency of 100%. Results may vary per actual order.

6" 20W Square Trim

Lumens: 1515.4lm
 Watts: 20 W
 LPW: 75.77lm/W
 CCT: 4000K

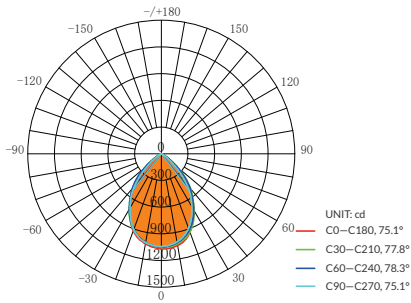

AVERAGE BEAM ANGLE(50%): 76.6 DEG

6" 20W Square Wall Wash

Lumens: 1590.6lm
 Watts: 20 W
 LPW: 79.53lm/W
 CCT: 4000K

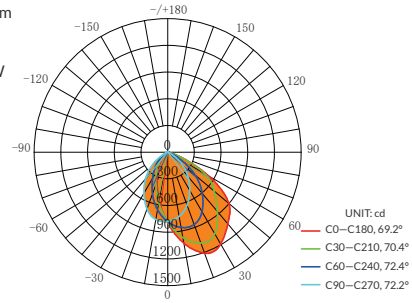

AVERAGE BEAM ANGLE(50%): 71.0 DEG

6" 40W Round Trim

Lumens: 3328.0lm
 Watts: 40 W
 LPW: 83.2lm/W
 CCT: 4000K

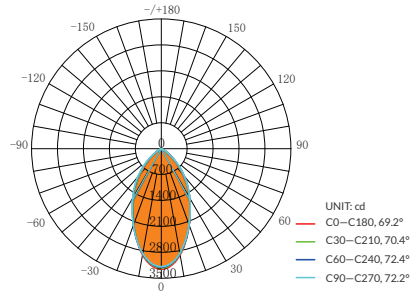

AVERAGE BEAM ANGLE(50%): 57.4 DEG

6" 40W Round Wall Wash

Lumens: 2949.1lm
 Watts: 40 W
 LPW: 73.73lm/W
 CCT: 3000K

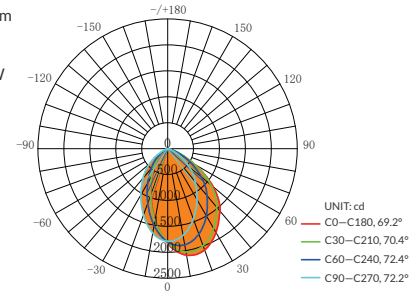

AVERAGE BEAM ANGLE(50%): 71.0 DEG

6" 60W Round Trim

Lumens: 6080.5lm
 Watts: 60 W
 LPW: 105.62lm/W
 CCT: 4000K

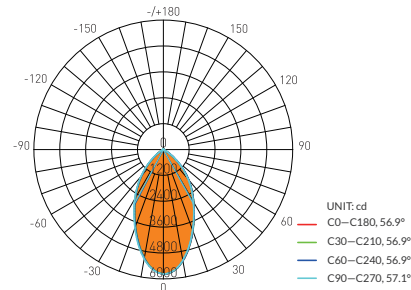

AVERAGE BEAM ANGLE(50%): 56.9 DEG

WARRANTY

5 years limited warranty.

Specifications subject to change without notice.