

SELECTABLE ECO VISION LED STRIP

Wide Size Ideal To Replace The 2 Lamp T8



Above All Lighting's Vision LED Strip Light has a sleek design with a diffuser lens. Wide size is ideal to replace the 2-lamp T8. Standard lengths come in 4ft and 8ft. Wide lumen range from 4,000lm to 11,000lm with high efficiency up to 143LPW. CCT and wattage selectable. Built-in sensor is available. Optional accessories include reflector, wire guard, V-hook and quick surface mount kits. It can be widely used in stairwells, warehouses, offices, garages, shop displays, and other commercial applications.

TECHNICAL DATA

Length	4ft, 8ft
Wattage	Selectable Power 32W/37W/47W Selectable Power 55W/63W/80W
CRI	80
CCT	Selectable 3000K/3500K/4000K
Driver	0-10V Dimming, Class 2 driver
Input Voltage	120-347V, 50/60Hz
Operating Temp.	-4°F to 104°F (-20°C to 40°C)
Certifications	cETLus conforms to UL Std. 1598 Cert. to CSA Std. C22.2 No.250.0 Suitable for damp locations RoHs compliant
Power Factor	>0.9 at full load
Harmonic Distortion	<20% at full load
Projected Lifetime	L70 - 156,000 Hours
IK Rating	IK10 rated

FEATURES

- 3000K, 3500K and 4000K selectable.
- Wattage selectable.
- 8% up-light and no glare.
- Quick and Easy to wire and install.
- Built-in sensor.
- Ceiling & wall surface mounted, suspension mounted.

SELECTABLE ECO VISION LED STRIP

Wide Size Ideal To Replace The 2 Lamp T8

SPECIFICATION

Side View

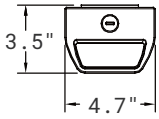

With Two Reflectors

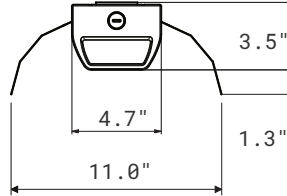

4ft

Net. Weight: 7.5 lbs

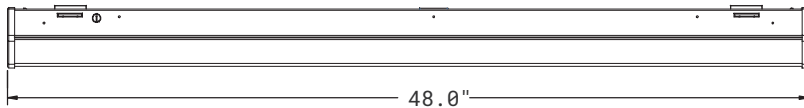

8ft

Net. Weight: 13.5 lbs

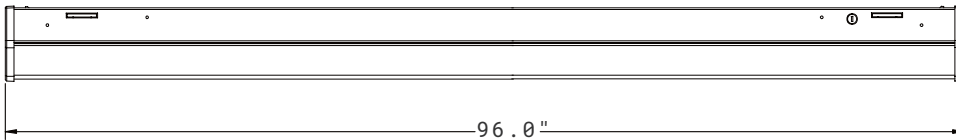

PHOTOMETRY

All published luminaire photometric testing performed to IESNA LM-79-08 standards by a NVLAP certified laboratory. IESNA LM-79-08 specifies the entire luminaire as the source resulting in a fixture efficiency of 100%. Results may vary per actual order.

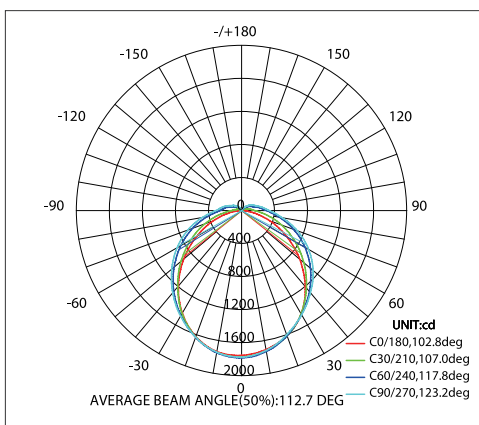

SELECTABLE ECO VISION LED STRIP

Wide Size Ideal To Replace The 2 Lamp T8



ORDERING INFORMATION

EXAMPLE: STR12DSP1LED8F-SE

STR					
1. Series	2. Dimension	3. Dimmable	4. Wattage	5. LED	6. CCT
STR	12 4ft	D 0-10V Dimmable	SP1 Selectable Power 32W/37W/47W ¹	LED	SW Selectable CCT 3000K 3500K 4000K ²
	24 8ft	D 0-10V Dimmable	SP2 Selectable Power 55W/63W/80W ¹		
	7. Voltage	8. Lens	9. Control	10. Series	
	8 120-347V	F Frosted lens ³	BLANK None MSW Microwave Motion Sensor ⁴	SE ECO	

NOTE:

- 32W for 4ft and 63W for 8ft are default setting, If other wattage needed please change the setting in the field.
- 4000K is default setting. If other CCT needed please change the setting in the field.
- Frosted lens is standard. Please contact Customer Service for the lead time of clear lens.
- Microwave dimming sensor for mounting height 20ft max. Dimming default setting is Bi-Level dim, 50% on vacancy and 100% on Occupancy. Daylight sensor default setting is disabled . If other settings needed such as 20% or 30% dimming, ON/OFF function, and daylight sensor function, please consult with customer service in advance.
- Surface mount is standard. If quick surface mount or V-hook mount is needed, please order the mounting brackets separately. Please check the accessory table for details.
- MSW can read vibration as movement and trigger the sensor despite no physical movement in the sensor field. As such, MSW should not be installed in rooms that experience significant levels of vibration.
- Standard Finish is White. Custom colors might be available for an additional fee. Please check with Customer Service for more information.

ACCESSORIES (ORDERED SEPARATELY)

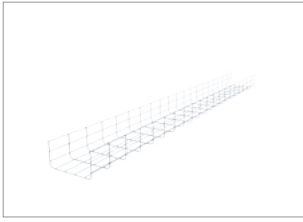

STRP12-WG¹
Wire guard for 4ft and 8ft strip.



STRP-QSMK³
Quick surface mount kit for ceiling and wall mount (a pair).

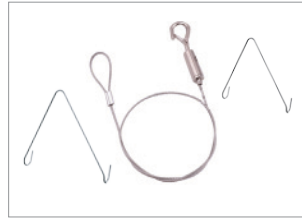

STRP-VH
V-hooks for strip.

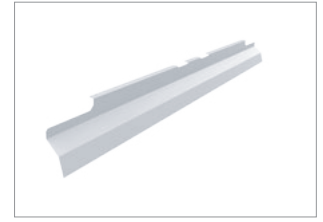

STRP09-RF
Reflector for 3ft strip.

STR-PMK
Pendant Mount Kits for strip (a pair).

STRP12-RF²
Reflector for 4ft and 8ft strip.



BMS-L104-B1-PIR-1-BLE-KL-SMO
Passive Infrared (PIR) Bluetooth Sensor.



MH10
Remote control for MSW.

NOTE:

1. If for 8ft please order two pieces.
2. If this reflector will be installed at one side, then one piece for 4ft and two pieces for 8ft. If this reflector will be installed at both two sides, then two pieces for 4ft and four pieces for 8ft.
3. Soft chain mount with V-hooks is the best choice if fixture is with MSW and needed to be installed on a ceiling of long time vibration.

PERFORMANCE DATA

Lumen values are measured by third party certified laboratories performed in accordance with IESNA LM-79-08 as well as Lighting Facts listed.

Wattage	Lumen Output	Size	CRI	AC Input 120V	CCT	LPW
32W	4580lm	4ft	80	0.27A	3500K/4000K	143
37W	5180lm	4ft	80	0.30A	3500K/4000K	140
47W	6350lm	4ft	80	0.39A	3500K/4000K	135
55W	7860lm	8ft	80	0.46A	3500K/4000K	143
63W	8820lm	8ft	80	0.52A	3500K/4000K	140
80W	10800lm	8ft	80	0.67A	3500K/4000K	135

NOTE:

- For 3000K fixtures, use 0.96 multiplier.

Projected LED Lumen Maintenance

Data references the extrapolated performance projections for the LED strip in a 77°F ambient, (tested per IESNA LM-80-08 and projected per IESNA TM-21-11).

Operating Hours	10,000	19,000	38,000	156,000
Lumen Maintenance Factor	0.98(L98)	0.96(L96)	0.92(L92)	0.70(L70)

Lumen Ambient Temperature (LAT) Multipliers

Use these factors to determine relative lumen output for average ambient temperature from -4°F to 104°F (-20°C to 40°C).

Ambient		Multiplier
Celsius	Fahrenheit	
0	32	1.06
10	50	1.03
20	68	1.01
25	77	1.00
30	86	0.99
40	104	0.97

SELECTABLE ECO VISION LED STRIP

Wide Size Ideal To Replace The 2 Lamp T8

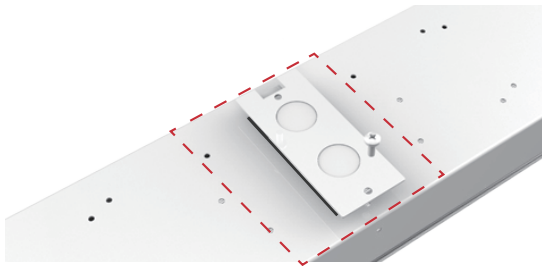

Easy to wire. End and back side wire entries available, meet different junction box locations.

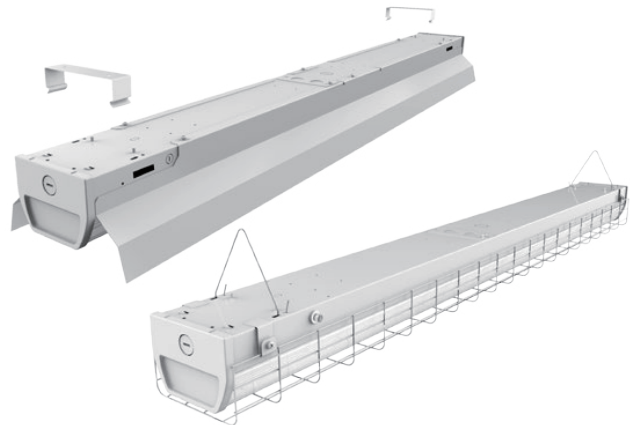

Easy to install. Quick ceiling & wall surface mount and V-hook mount optional, no need to open the housing.

MICROWAVE DIMMING SENSOR

The sensor is an innovative motion sensor, switch on the light on detection of movement, and switch off after a hold time when there is no motion detected.

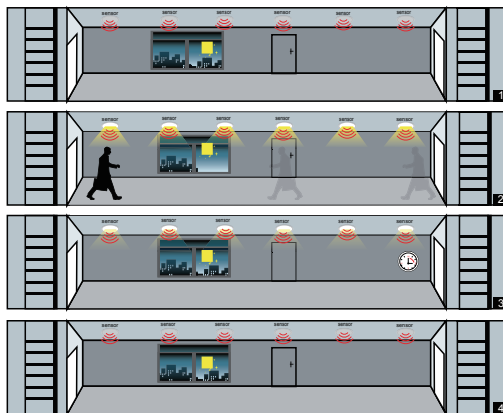

1. No motion detected, all lamps switch off.
2. Any movement is detected from any direction, all lamps synchronously switch on.
3. No motion is detected in detection area, all lamps synchronously dim to a low light level after hold time.
4. After stand-by period, the lamps switch off if no movement is detected in the detection zone.

MICROWAVE DIMMING SENSOR SETTING (120-347V)

Sensor data can be precisely set for each specific application by a remote controller which need to be bought separately.

Detection area

Detection area can be reduced by selecting the combination on the remote controller to fit precisely each application.
Optional Setting: 100%/75%/50%/25%.

Default Setting: 100%

SELECTABLE ECO VISION LED STRIP

Wide Size Ideal To Replace The 2 Lamp T8

Hold time

Refers to the time period the lamp remains at 100% illumination after no motion detected.
Optional Setting: 5s/30s/1min/3min/5min/10min/20min/30min.

Default Setting: 20mins

Stand-by period

Refers to the time period the lamp remains at a low light level before it completely switches off in the long absence of people. When set to “+∞” mode, the low light is maintained until motion is detected.
Optional Setting: 0s/10s/1min/3min/5min/10min/30min/+∞.

Default Setting: +∞

Notes: If just need ON/OFF function, please set the stand-by period in "0S" mode by the remote controller.

Daylight sensor

The sensor can be set to only allow the lamp to illuminate below a defined ambient brightness threshold. When set to Disable mode, the daylight sensor will switch on the lamp when motion is detected regardless of ambient light level. 50lux, 30lux: twilight operation, 10lux, 5lux: darkness operation only. Note that daylight sensor is active only when lamp totally switches off.

Optional Setting: 5lux/15lux/30lux/50lux/100lux/150lux/Disable.

Default Setting: Disable

Stand-by dimming level

The low light level you would like to have after the hold time in the long absence of people.
Optional Setting: 10%/20%/30%/50%.

Default Setting: 50%

BLUETOOTH PIR MOTION SENSOR

Model No.	Description
BMS-L104-B1-PIR-1-BLE-KL-SMO	Passive Infrared (PIR) Bluetooth Sensor
LS03-HB1-2-WH	HB1 High Bay Lens
LS03-HB3-2-WH	HB3 High Bay Lens

SELECTABLE ECO VISION LED STRIP

Wide Size Ideal To Replace The 2 Lamp T8

BLUETOOTH MESH CONTROL

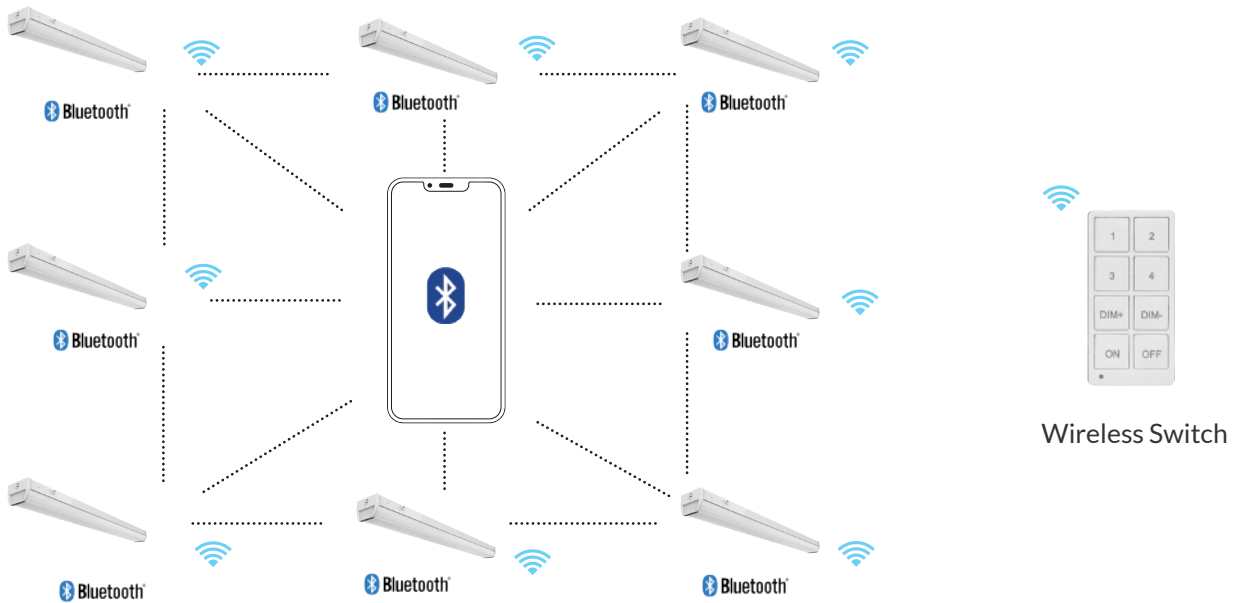

WIRELESS SWITCH OPTIONS



BMWS-L-D-1-3BT-
BLE-KL-WH



BMWS-L-D-5BT-
BLE-KL-WH



BMWS-L-D-1-7
BT-BLE-KL-WH



BMWS-L-D-8BT-
BLE-KL-WH



DETECTION AREA

HB1 High Bay Lens

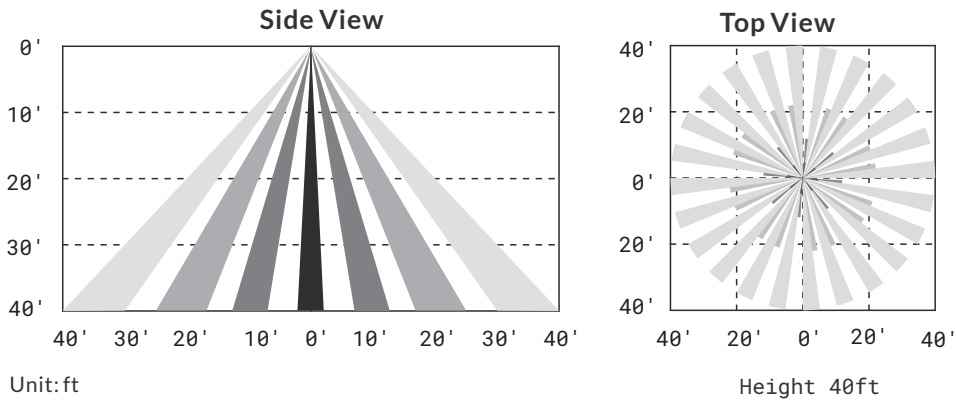

HB3 High Bay Lens

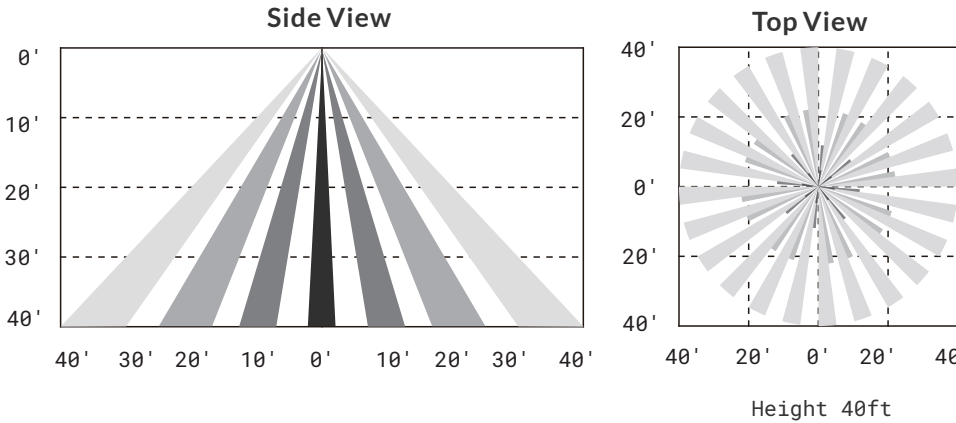

DETECTING SPOTS FOR REF

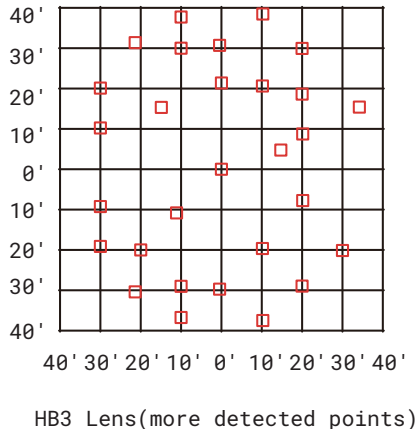
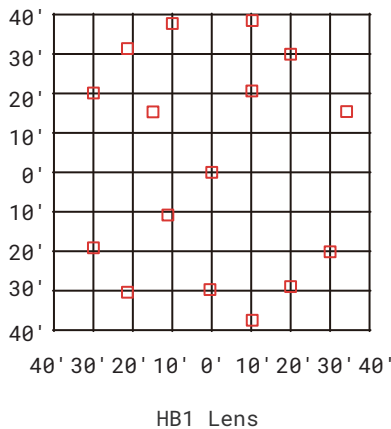

SELECTABLE ECO VISION LED STRIP

Wide Size Ideal To Replace The 2 Lamp T8



Ref#: 20260707

WARRANTY

5 years limited warranty.

Specifications subject to change without notice

Note:

Please refers to the instruction manual for motion sensor default setting.